

## ÇELİK TAKVİYELİ CEPHE 101

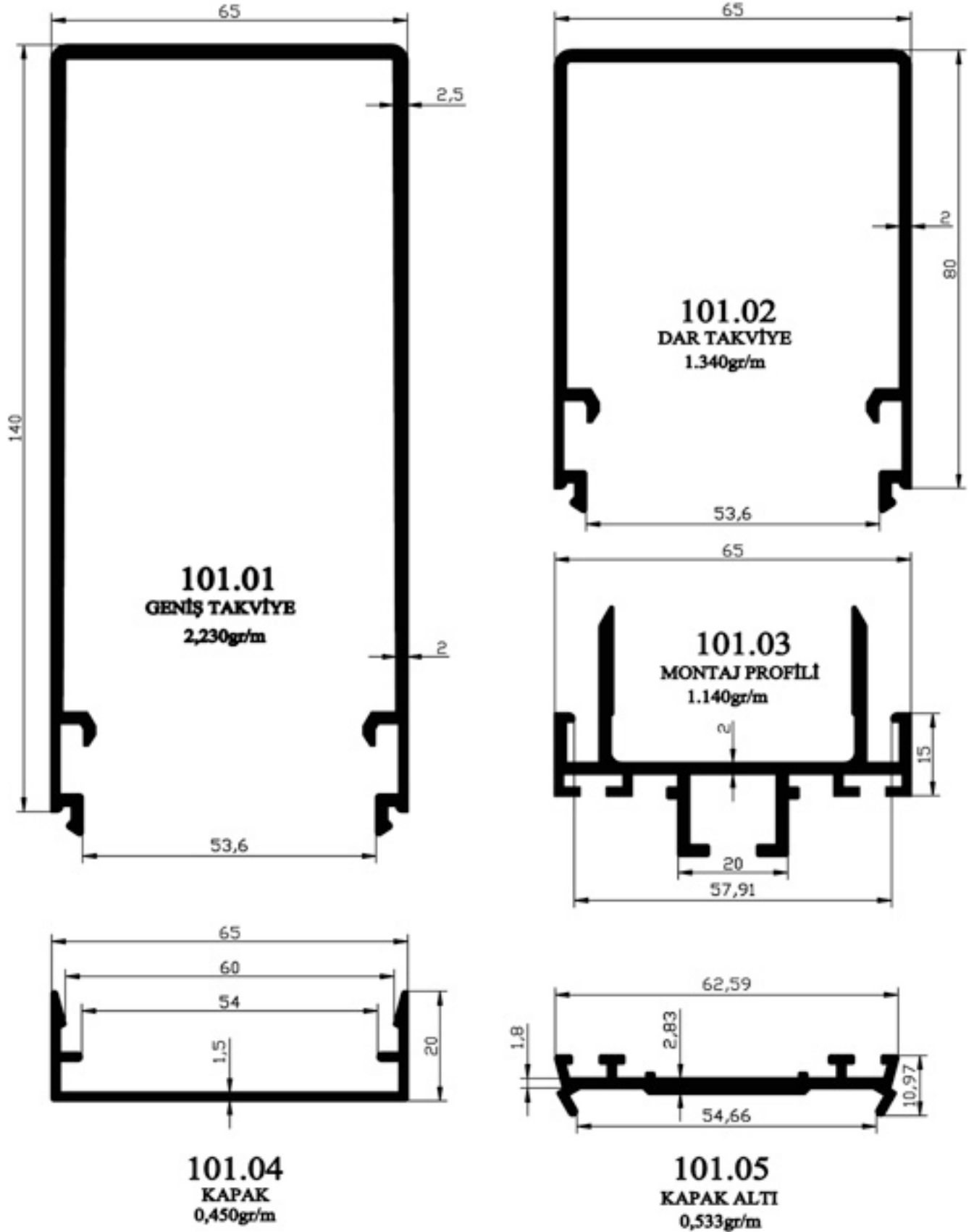

## ÇELİK TAKVİYELİ CEPHE 101



## KAPAKLI GIYDIRME CEPHE 102

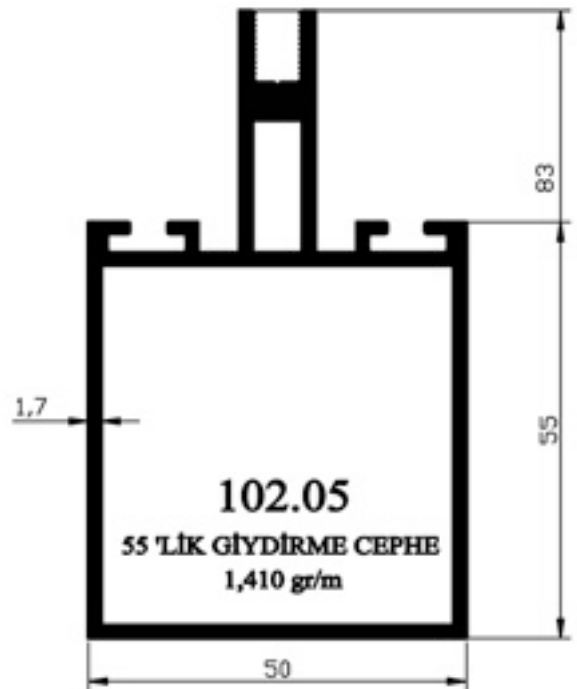
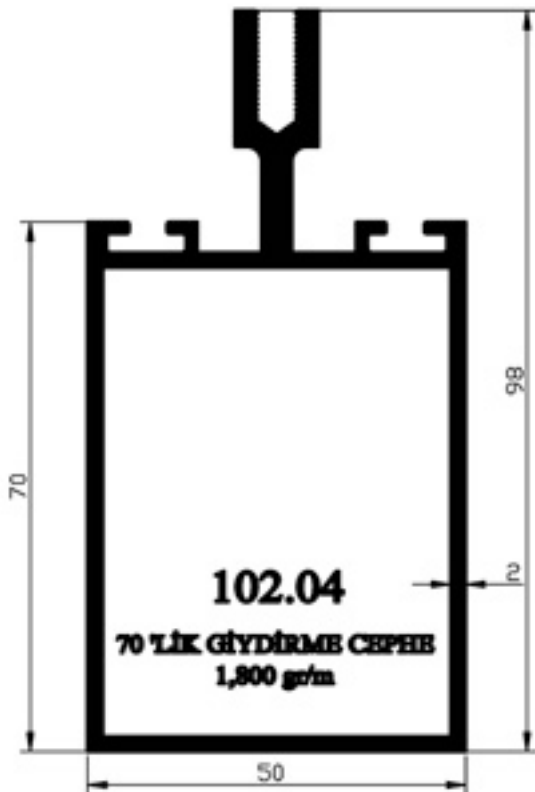
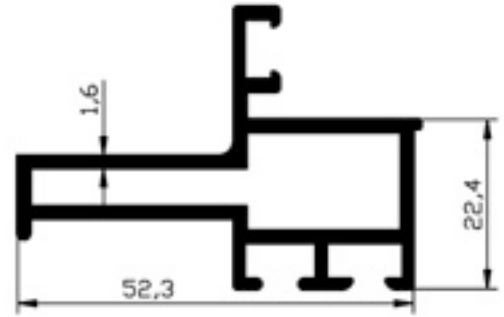
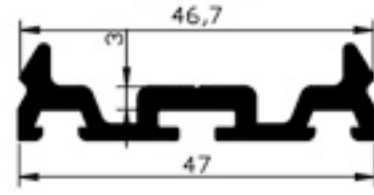
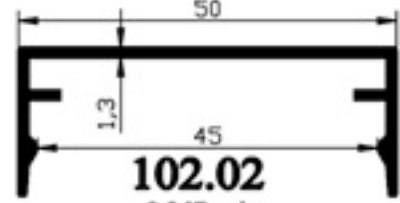
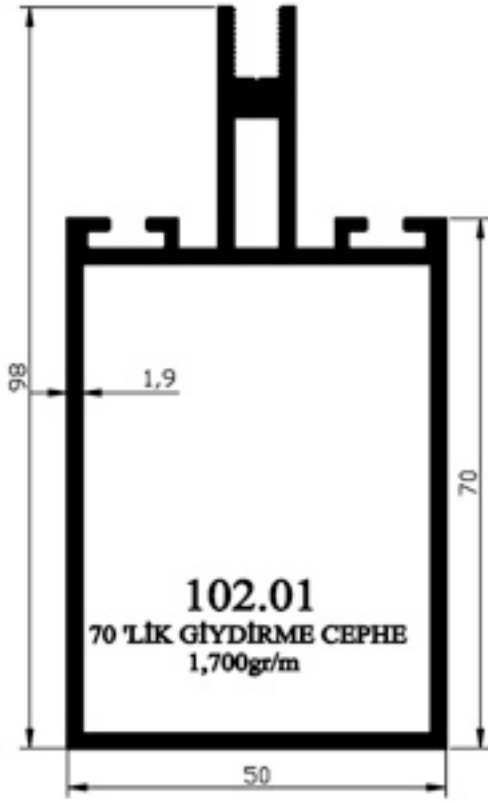

## SİLİKONLU CEPHE 102

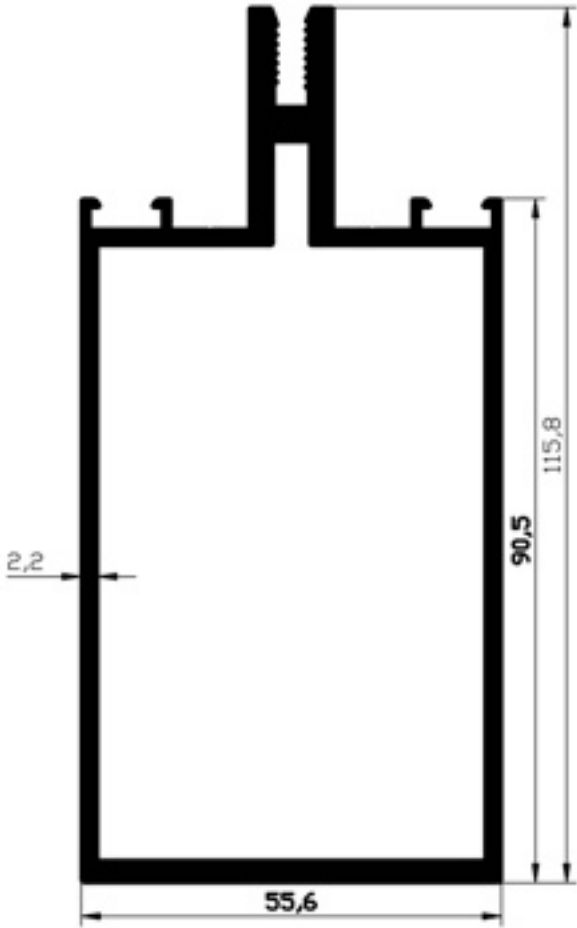

**102.06**  
2.379 gr/m

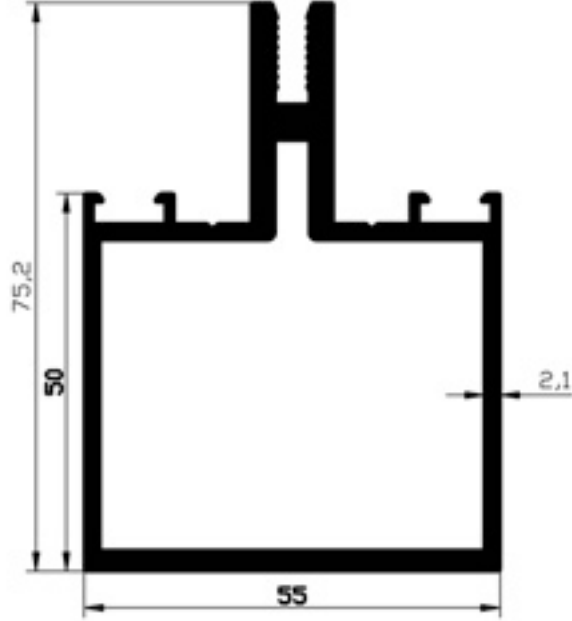

**102.08**  
1.819 gr/m

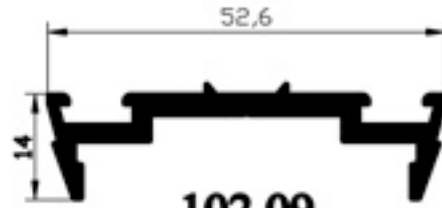

**102.09**  
0.567 gr/m

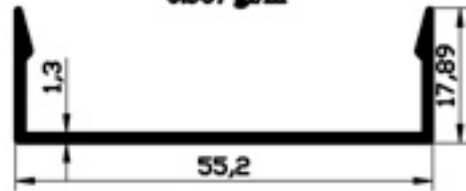

**102.07**  
0.319 gr/m

SİLİKONLU CEPHE 102

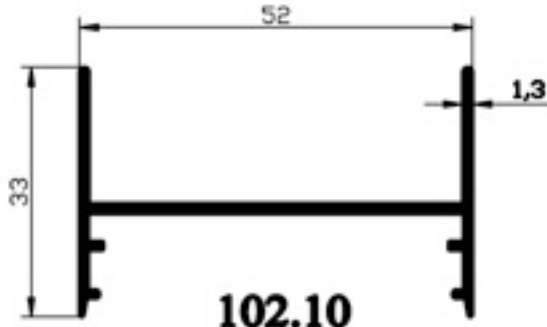

**102.10**  
0,427 gr/m

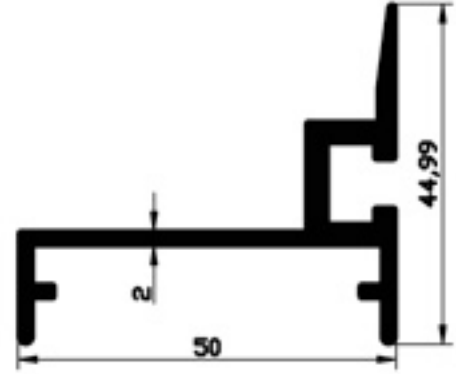

**102.11**  
0,773 gr/m



**102.12**  
0,510 gr/m

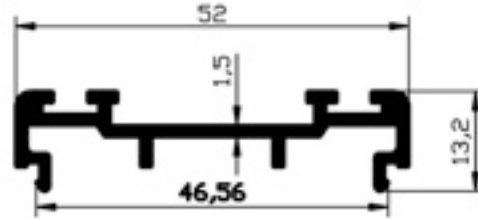

**102.13**  
0,457 gr/m

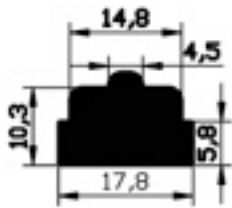

**102.18**  
0,477 gr/mt

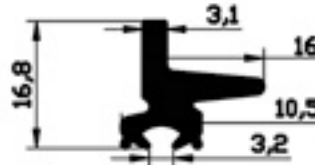

**102.20**  
0,306 gr/mt

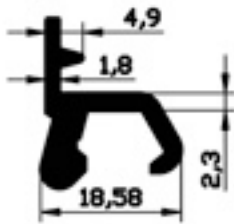

**102.19**  
0,336 gr/mt

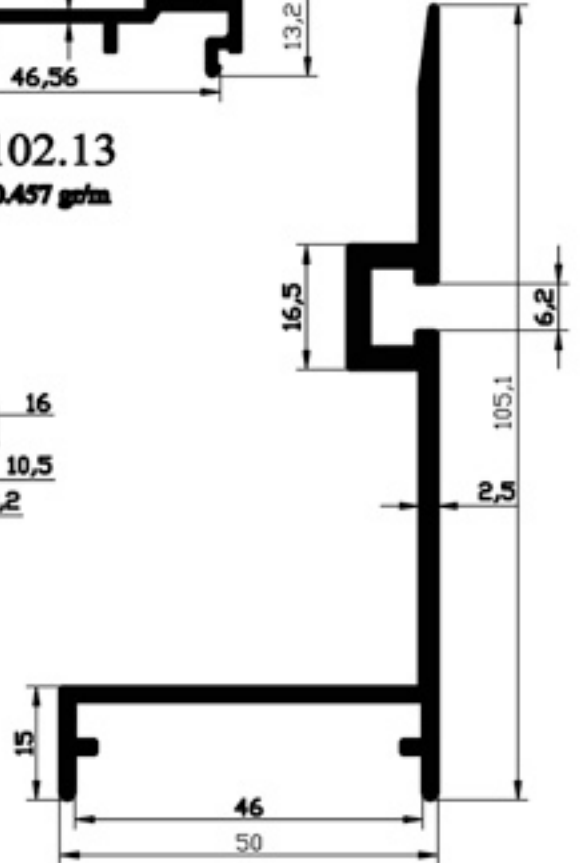

**102.14**  
1,231 gr/m

## SİLİKONLU ve KAPAKLI CEPHE 102

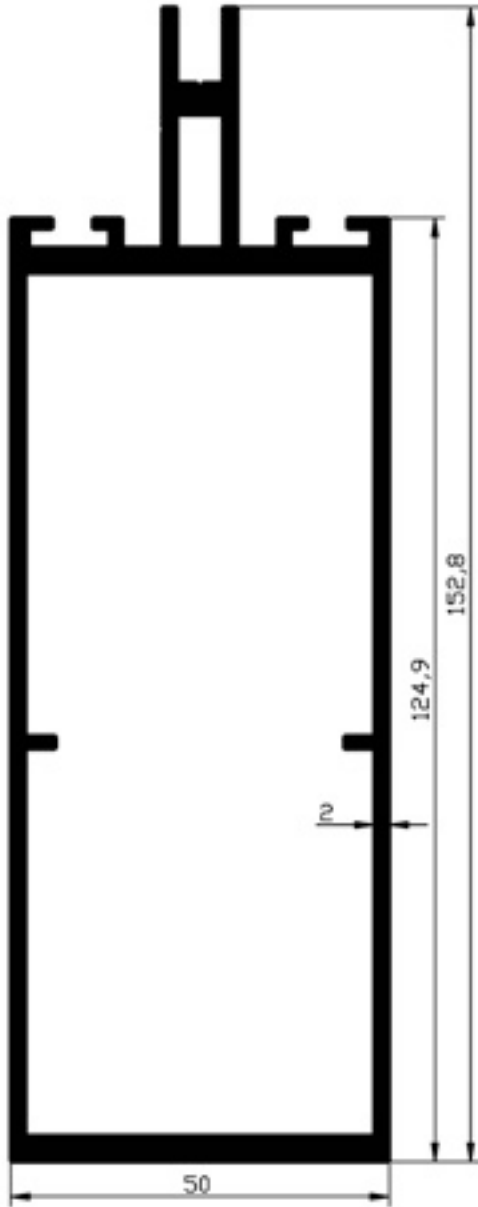

**102.15**  
2.769 gr/m

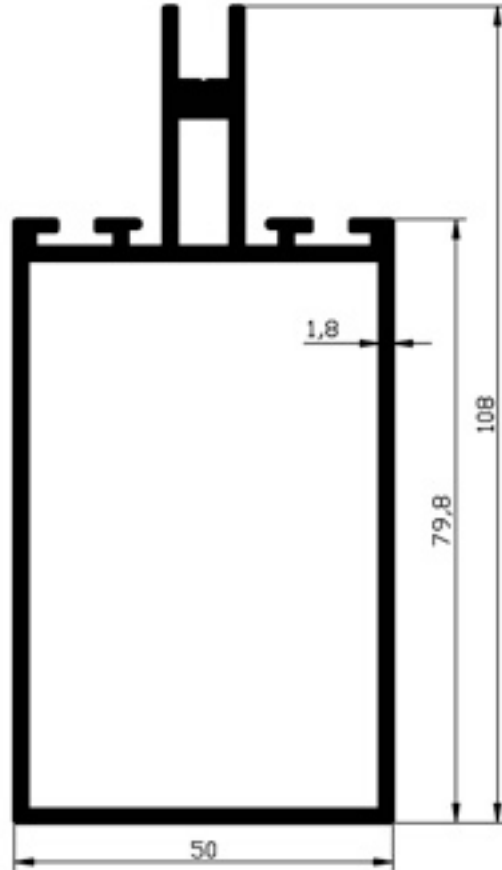

**102.16**  
1.744 gr/m

SİLİKONLU ve KAPAKLI CEPHE 102



**401.54**  
0.211 gr/m

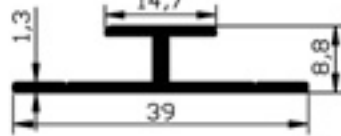

**401.55**  
0.222 gr/m

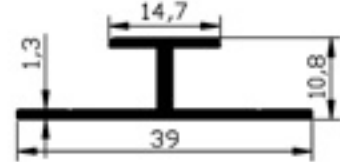

**401.56**  
0.233 gr/m

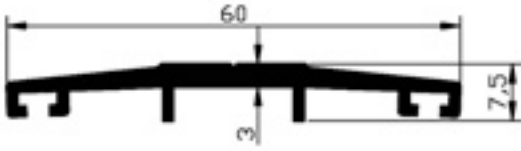

**701.61**  
0.461 gr/m

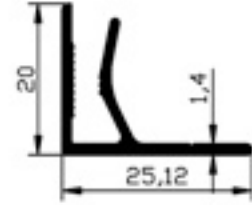

**101.06**  
0.217 gr/m

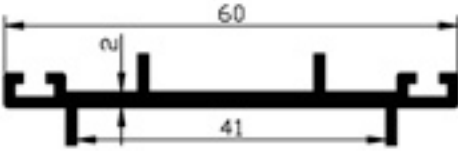

**701.62**  
0.426 gr/m

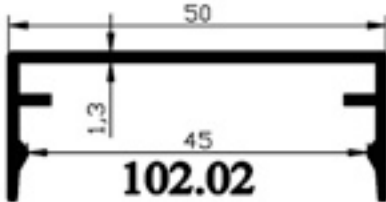

**102.02**  
0.347 gr/m

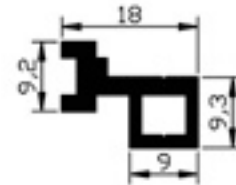

**102.25**  
0.263 gr/m

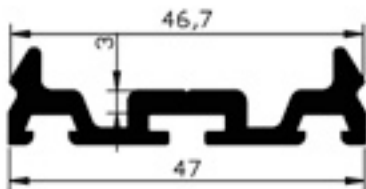

**102.03**  
0.588 gr/m

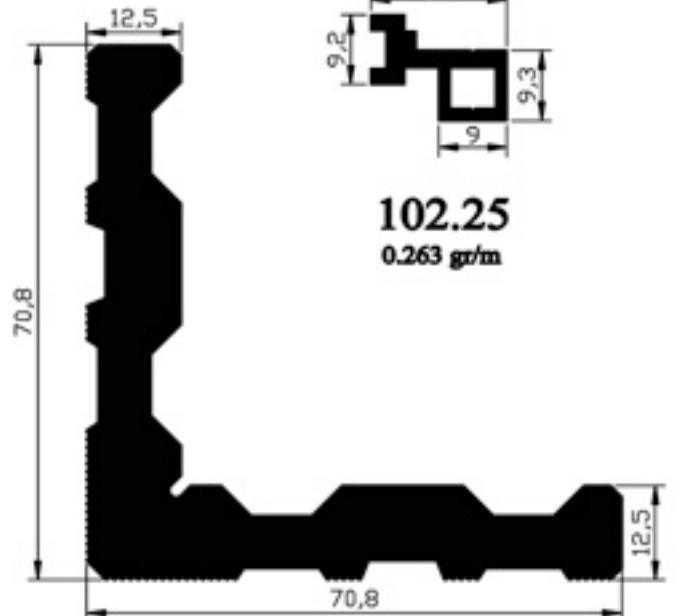

**325.31**  
3.482 gr/m

SİLİKONLU ve KAPAKLI CEPHE 102

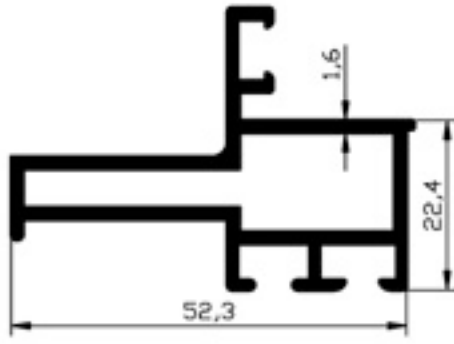

**102.17**  
0.780 gr/m

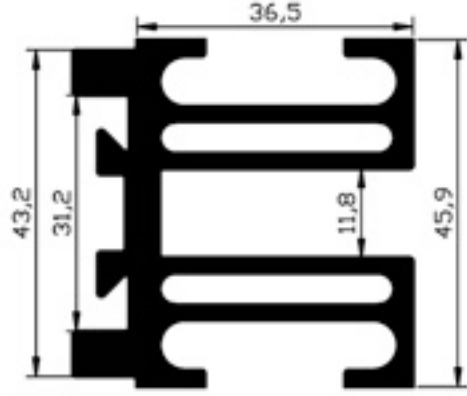

**701.06**  
1.955 gr/m

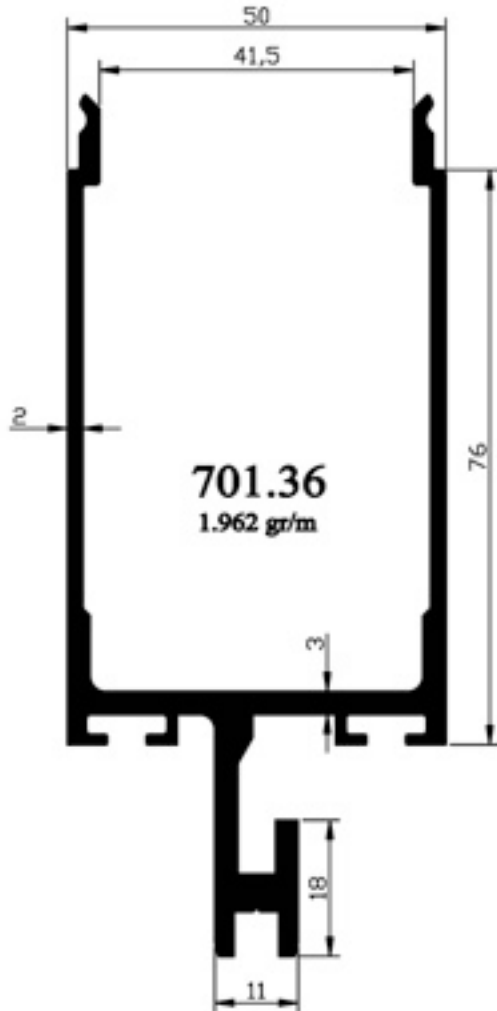

**701.36**  
1.962 gr/m

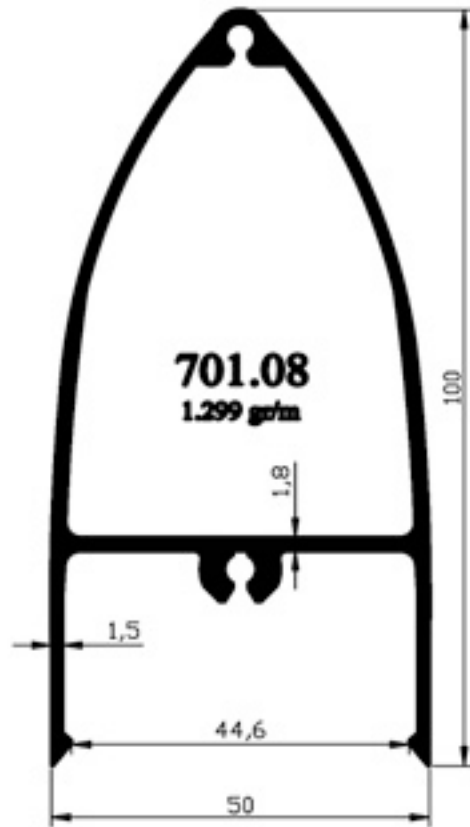

**701.08**  
1.299 gr/m



## SİLİKONLU ve KAPAKLI CEPHE 102

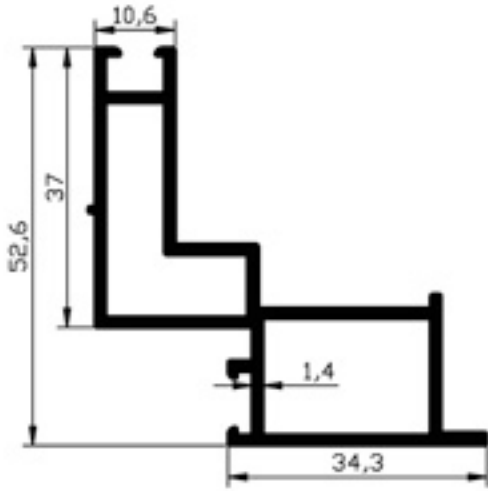

**701.04**  
0.796 gr/m

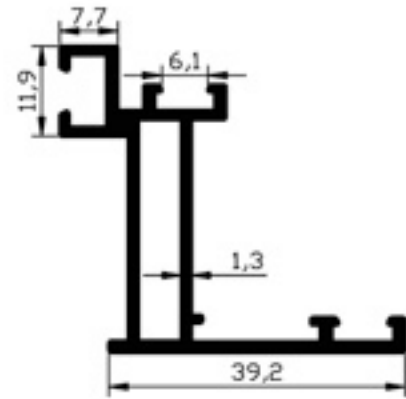

**701.05**  
0.582 gr/m

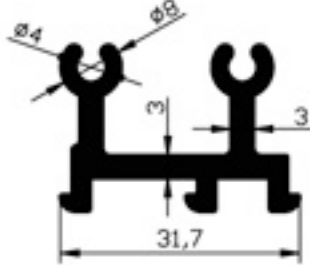

**701.23**  
0.635 gr/m

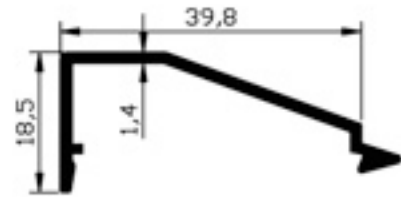

**701.27**  
0.273 gr/m

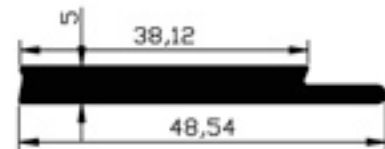

**701.28**  
0.575 gr/m

## SİLİKONLU ve KAPAKLI CEPHE 102

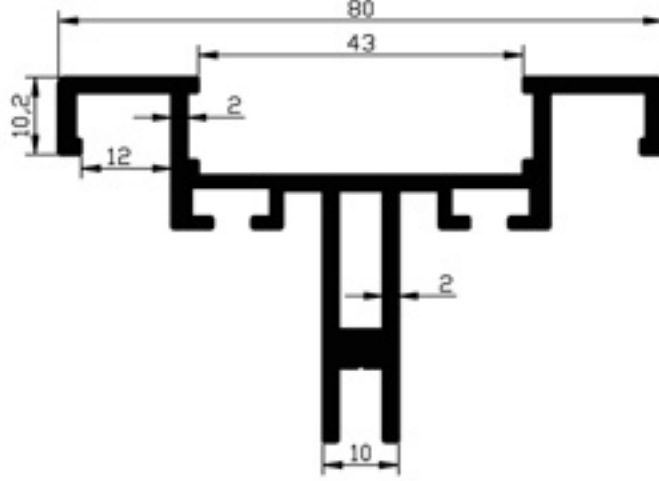

**701.24**  
1.274 g/m

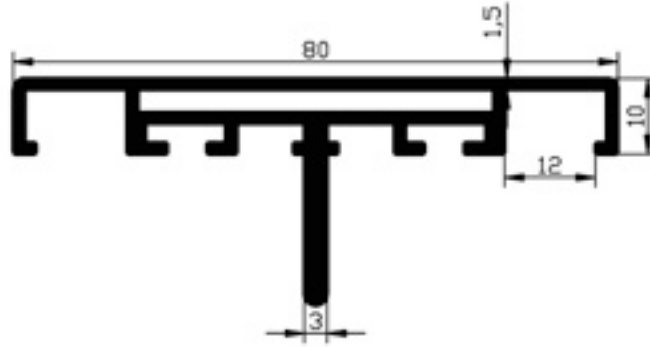

**701.25**  
0.963 g/m

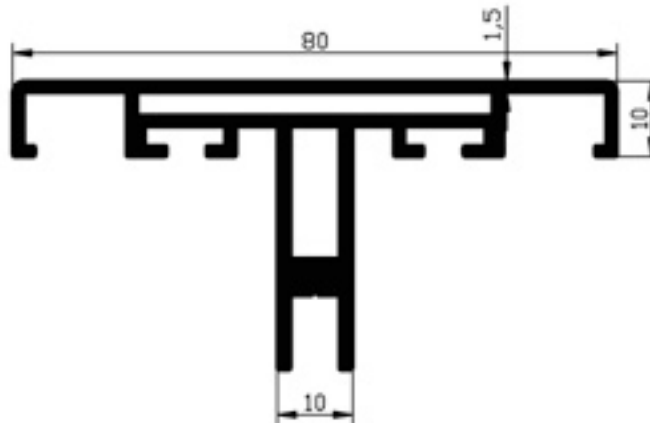

**701.26**  
1.161 g/m

## SİLİKONLU CEPHE DETAYI 102

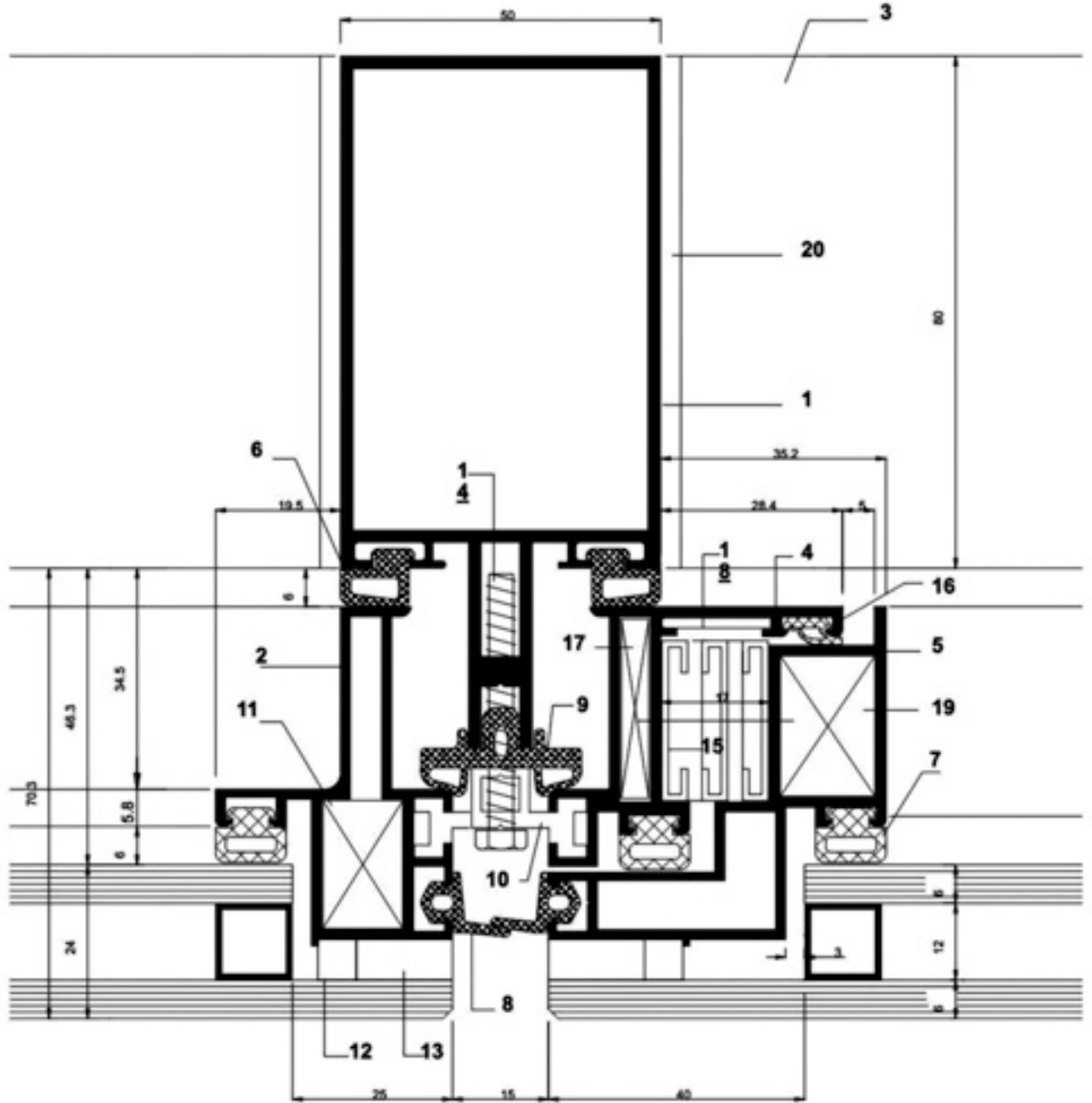

- 1- Düşey Profil
- 2- Kaset
- 3- Yatay Profili
- 4- Kasa Profili
- 5- Kanat Profili
- 6- Fitol
- 7- Fitol

- 8- Fitol
- 8a- Vulkanize
- 9- Fitol
- 10- Tespit Parçası
- 11- Köşe Takozu
- 12- Norton Bant
- 13- WACKER

- 14- Montaj Vidası
- 15- Makas
- 16- Fitol
- 17- Köşe Takozu
- 18- K Çavuşu
- 19- Köşe Takozu
- 20- Yatay Kayıt Contası

## GÜNEŞ KIRICILAR 103

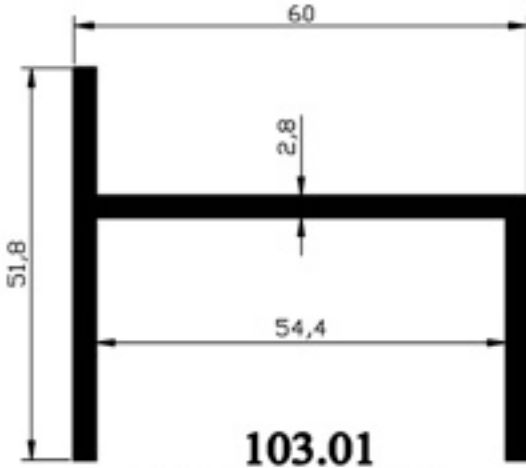

**103.01**  
GÜNEŞ KIRICI KASASI  
1,070gr/m



**103.02**  
GÜNEŞ KIRICI YAPRAĞI  
0,590gr/m

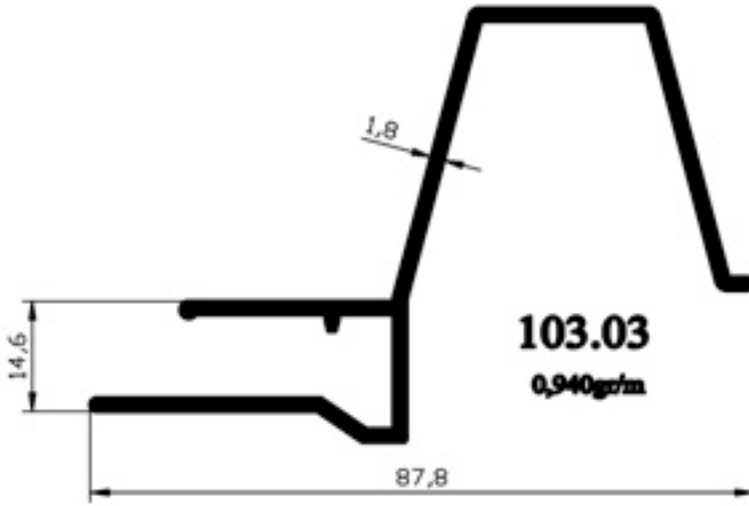

**103.03**  
0,940gr/m



**103.05**  
0,157gr/m

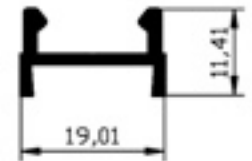

**103.06**  
0,152gr/m

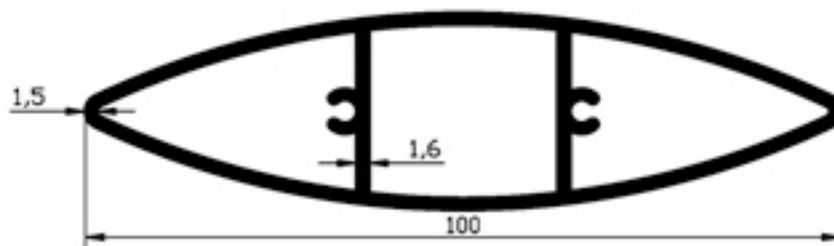

**103.04**  
1,085gr/m

## GÜNEŞ KIRICILAR 103

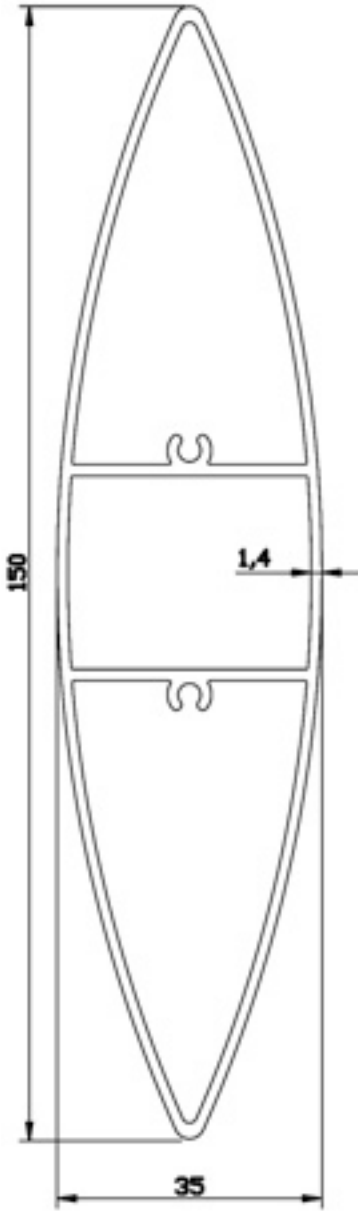

**103.07**  
1,493 gr/m

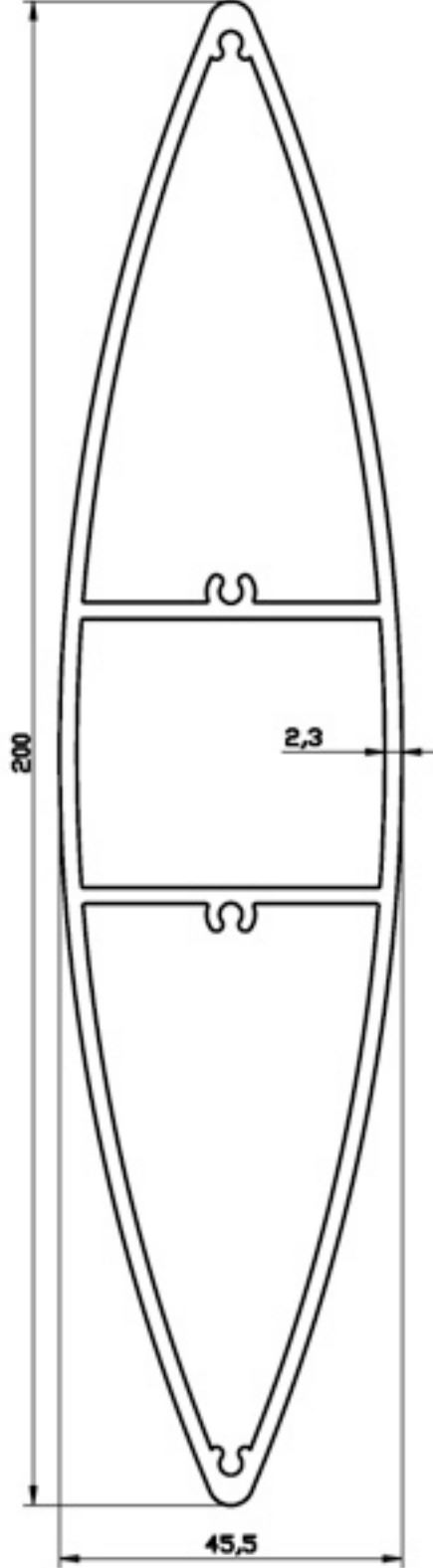

**103.08**  
3,107 gr/mt

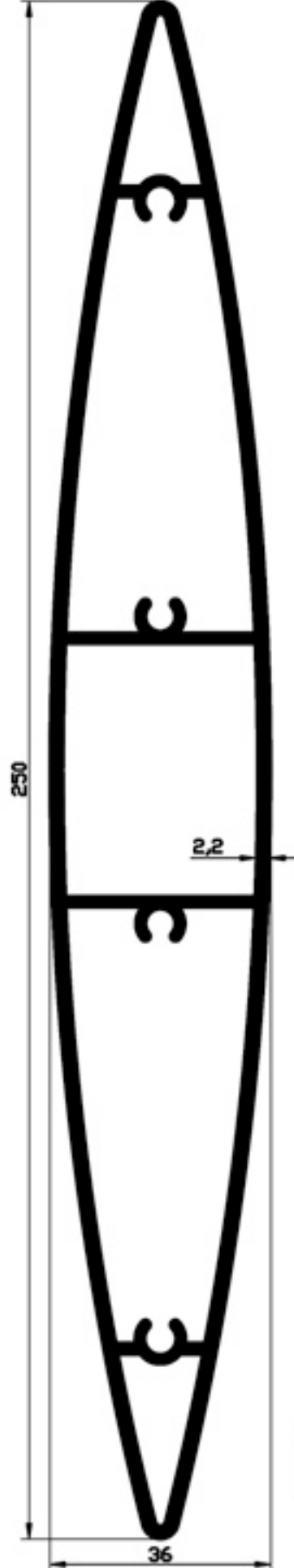

**103.11**  
3,640 gr/mt

## GÜNEŞ KIRICILAR 103

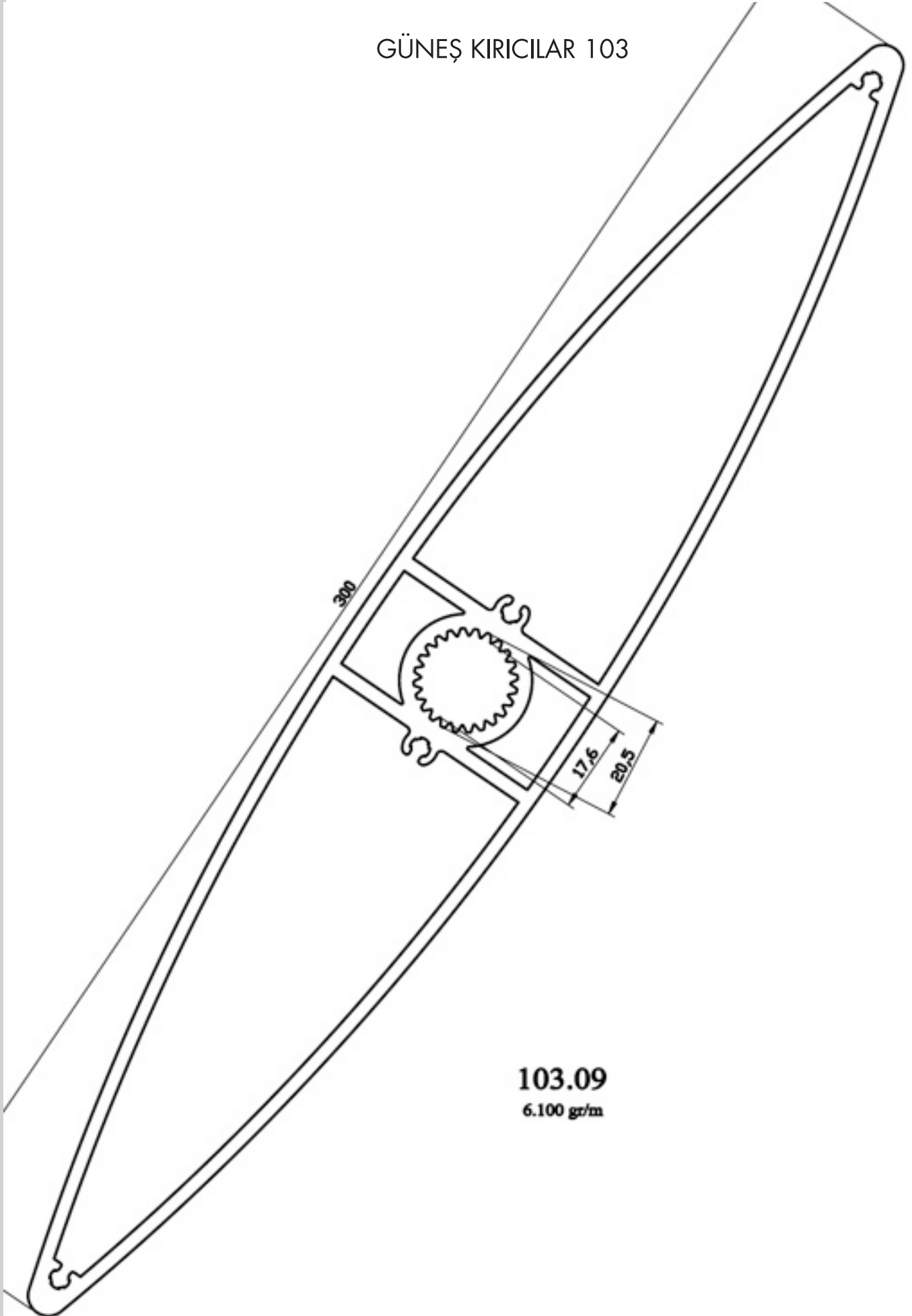

**103.09**

6.100 gr/m

## GÜNEŞ KIRICILAR 103

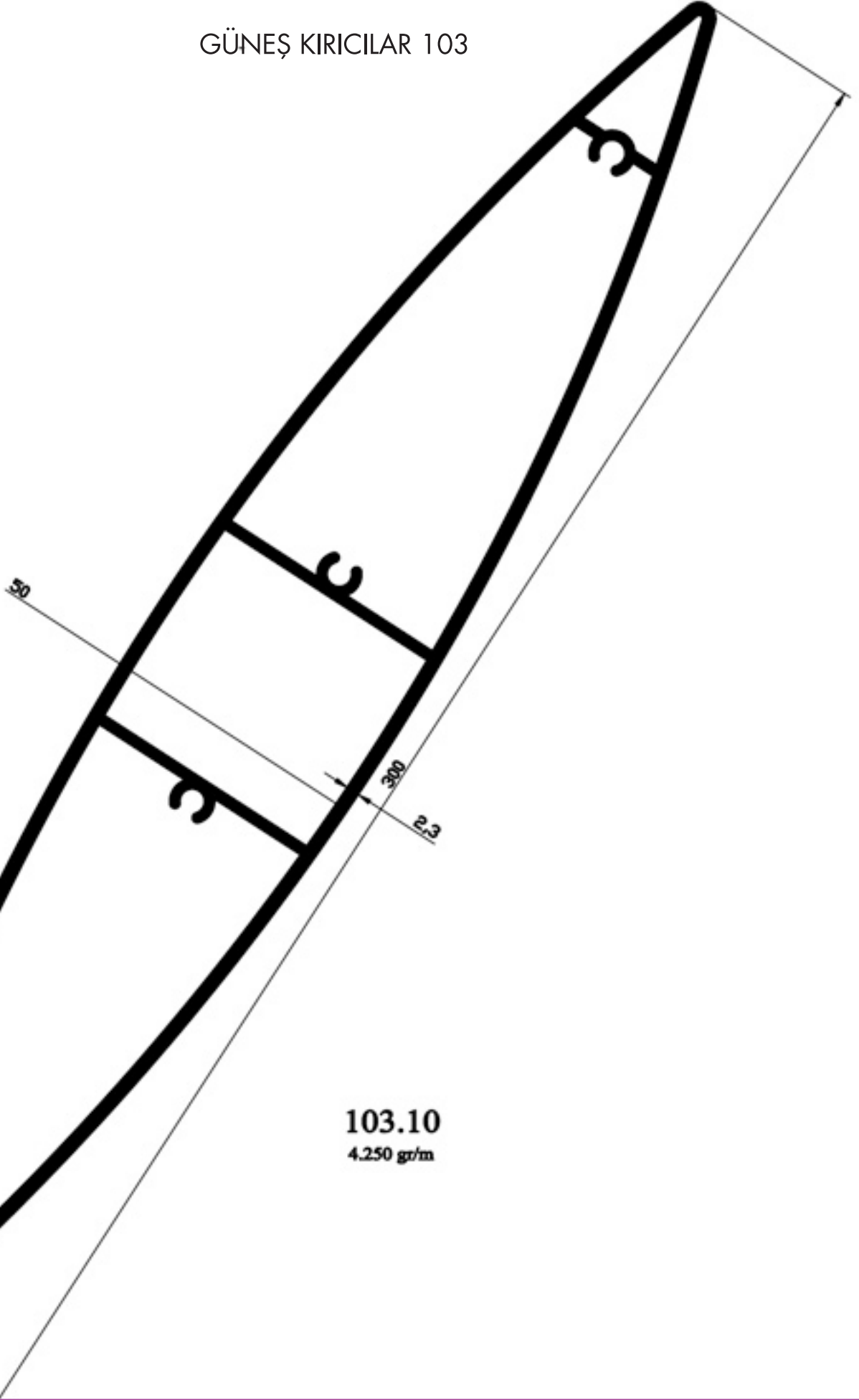

103.10  
4.250 gr/m

## GÜNEŞ KIRICILAR 103

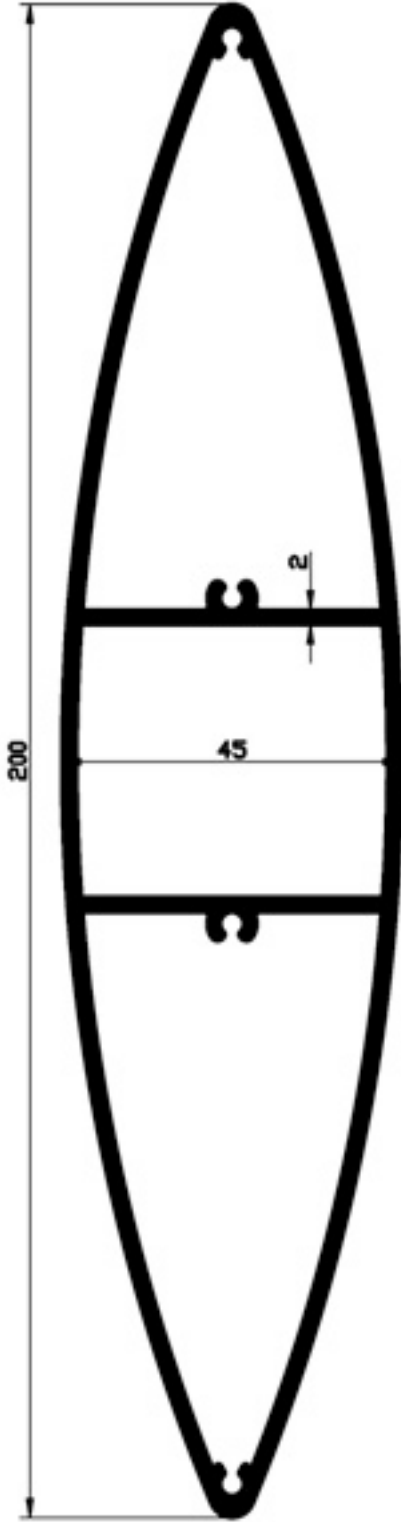

**103.13**  
2.772 gr/m

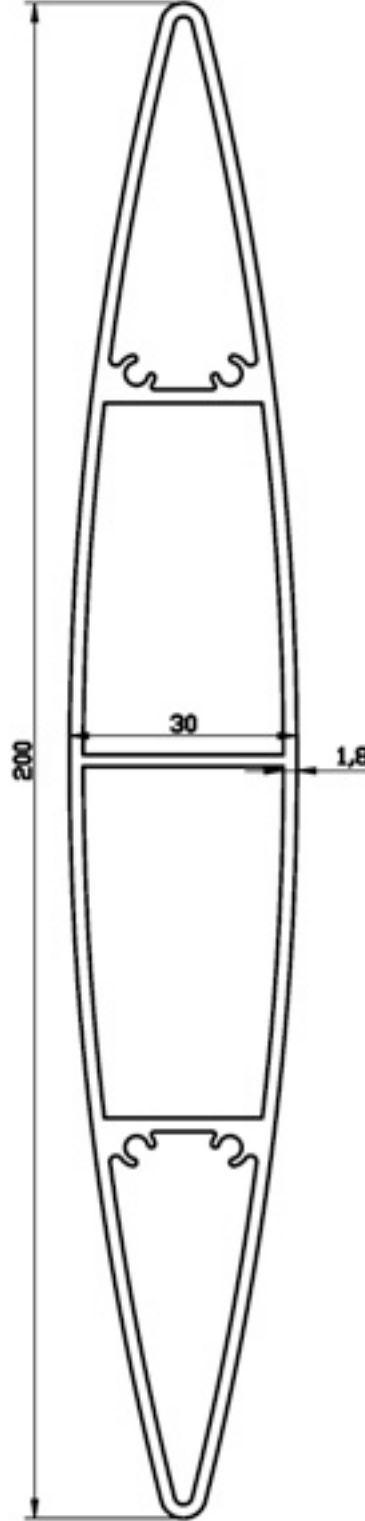

**705.01**  
2.724 gr/m

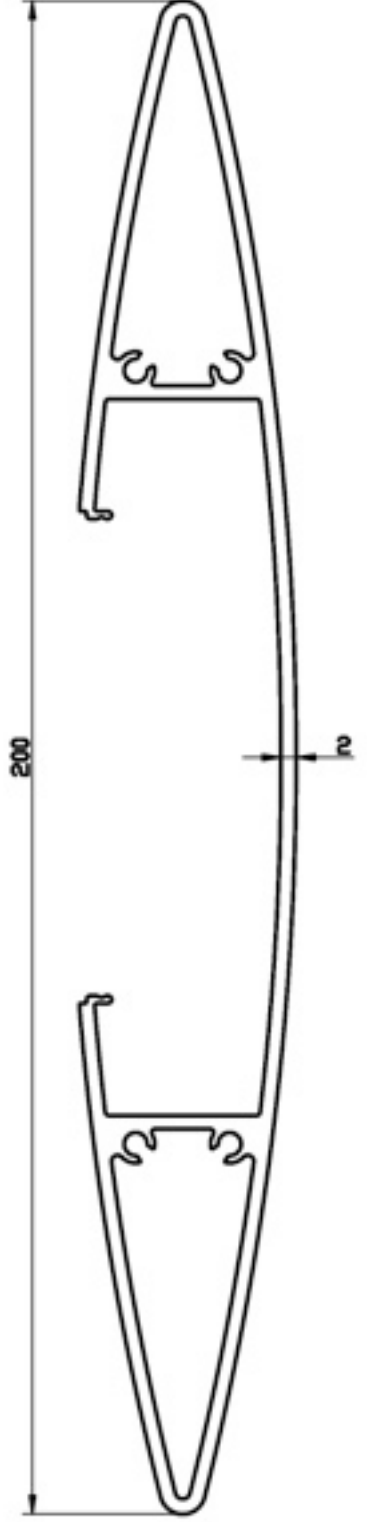

**705.03**  
2.218 gr/m



## GÜNEŞ KIRICILAR 103

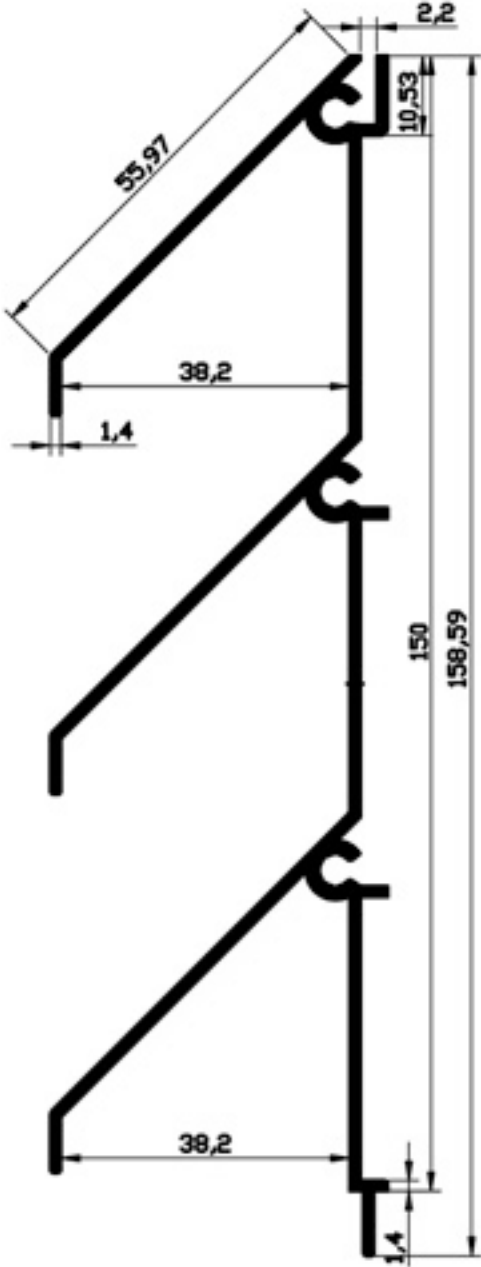

**701.30**  
1.475 gr/m

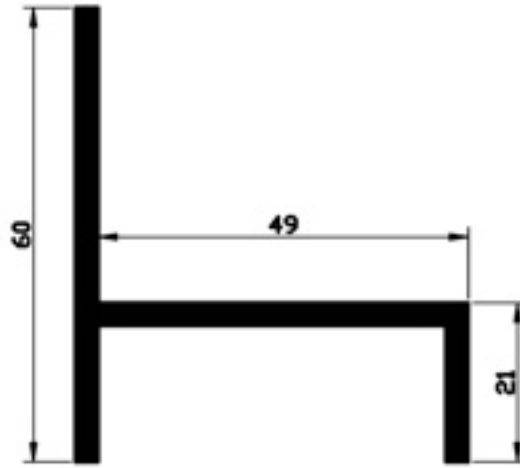

**701.31**  
1.032 gr/m

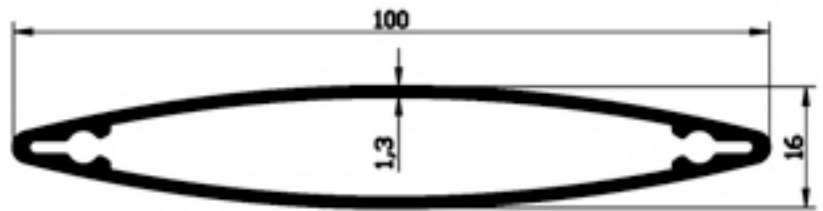

**103.12**  
0.777 gr/m

## BALKON CAMLAMA 104

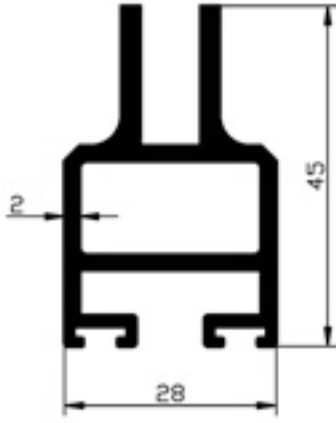

**104.01**  
**KANAT PROFİLİ**  
0.890gr/m

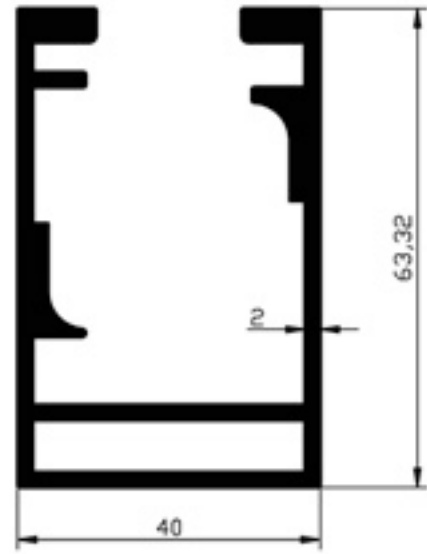

**104.02**  
**KASA PROFİLİ**  
1.549gr/m

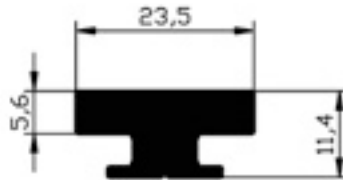

**104.03**  
**BAĞLANTI**  
0.513gr/m

## BALKON CAMLAMA 104

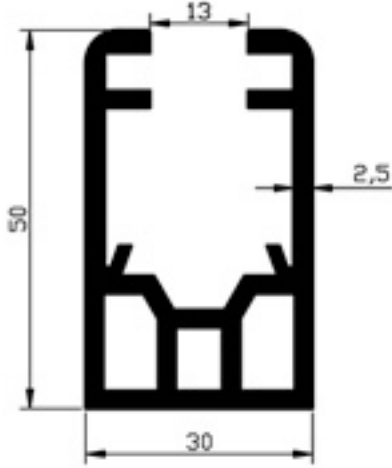

**104.04**  
BALKON CAMLAMA KASA  
1.300gr/m

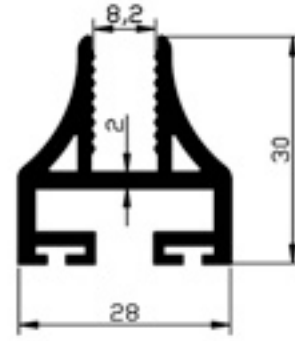

**104.05**  
BALKON CAM YATAĞI  
0,647gr/m

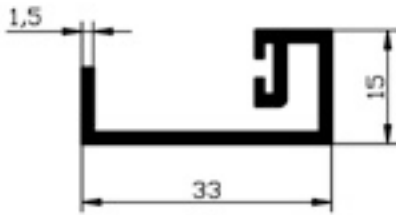

**104.06**  
BALKON CAM KENET  
0,313gr/m

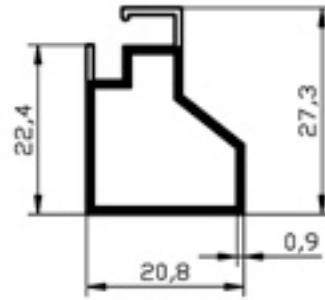

**108.03**  
SİNEKLİK  
0,233gr/m

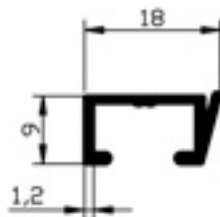

**104.08**  
PERDE RAY  
0,133gr/m

BALKON CAMLAMA 104

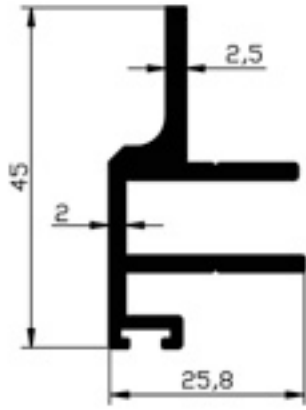

**104.22**  
0.612gr/m

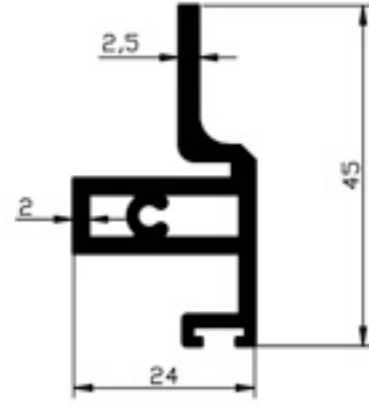

**104.23**  
0.675gr/m

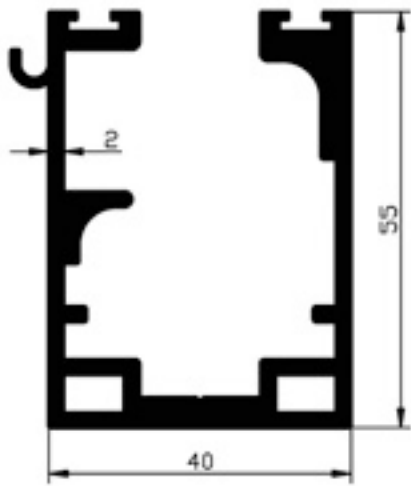

**104.24**  
1.512gr/m

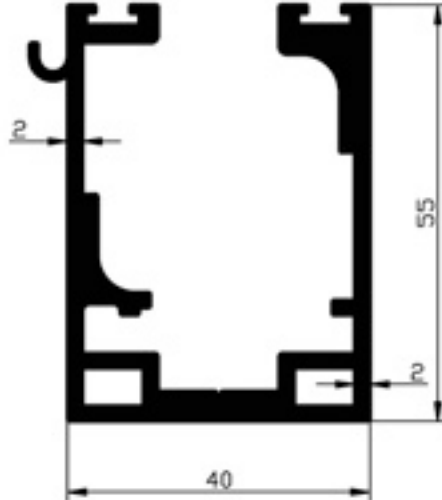

**104.25**  
1.527gr/m

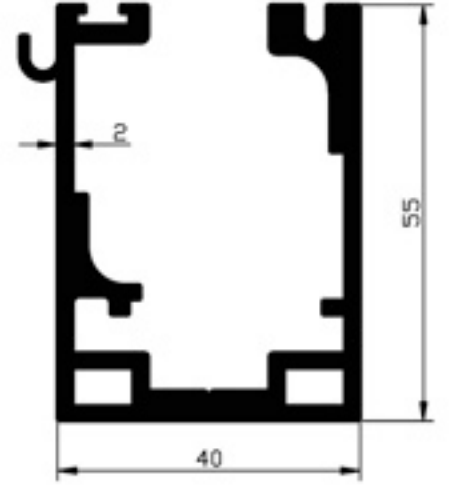

**104.26**  
1.536gr/m

## BALKON CAMLAMA 104

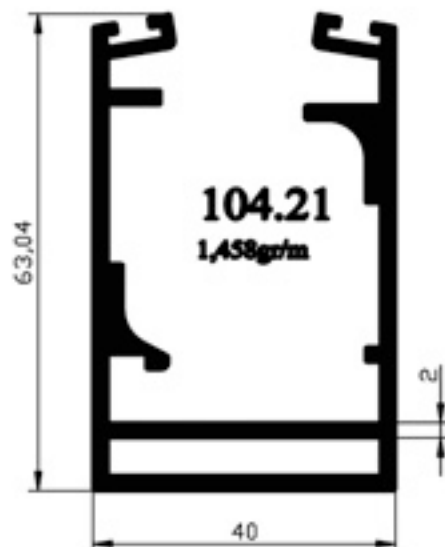
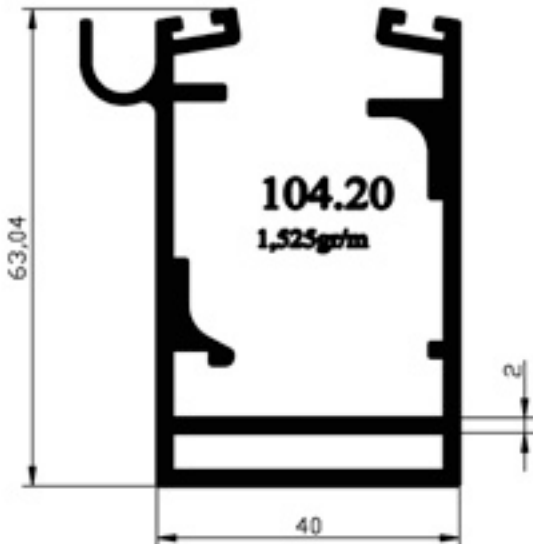
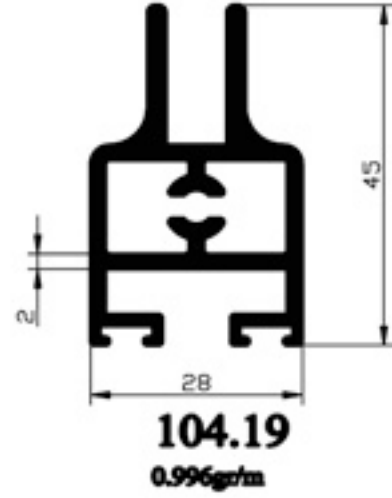
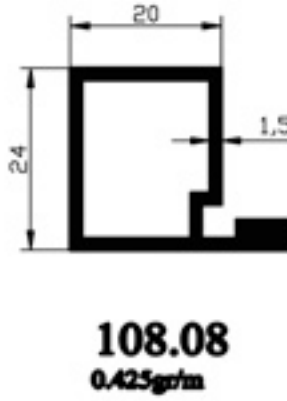
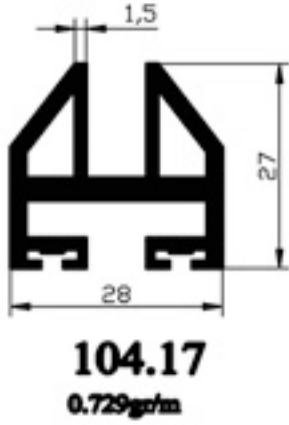
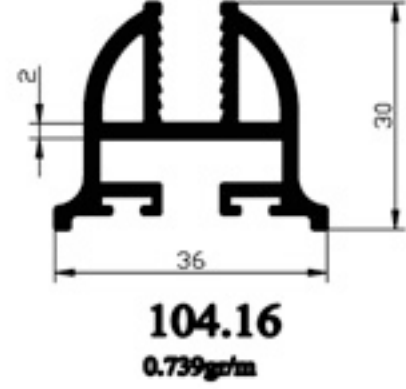
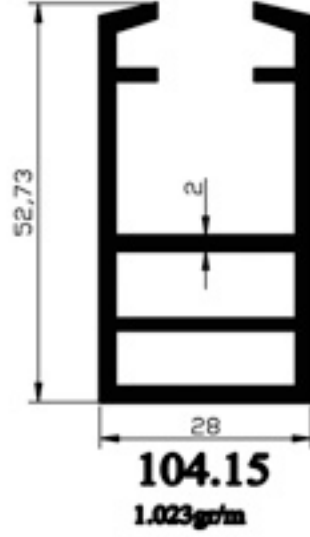
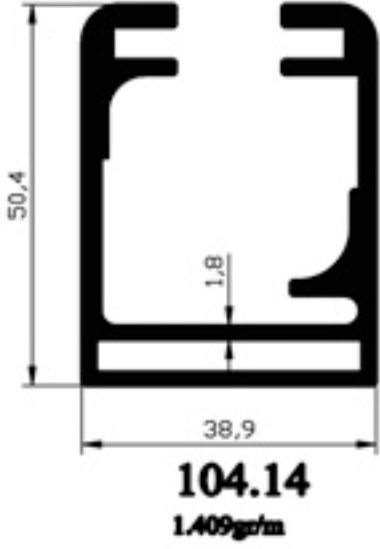

## DENİZLİKLER 25'LİK 105

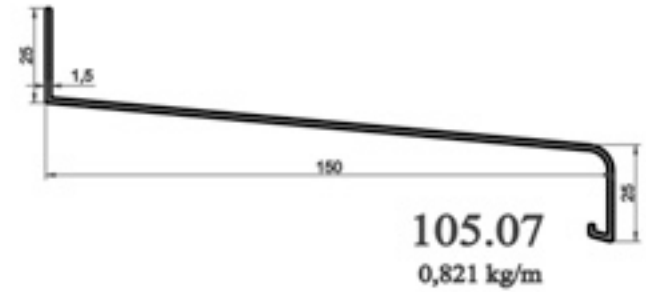
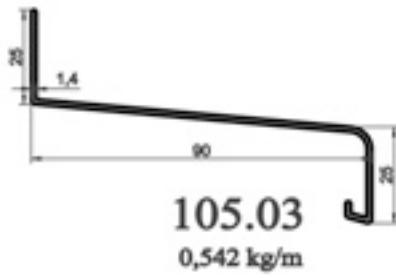
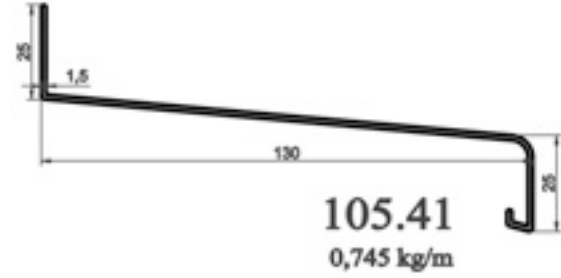
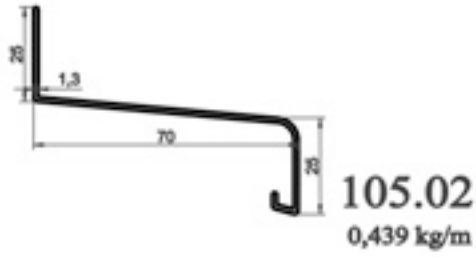
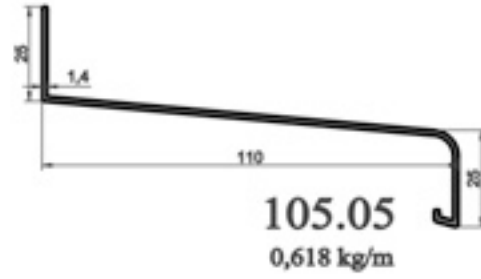
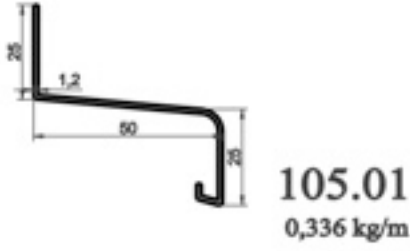

Tüm denizlik profillerinde +/- 0.3 mm kalınlık toleransı vardır.

## DENİZLİKLER 25'LİK 105

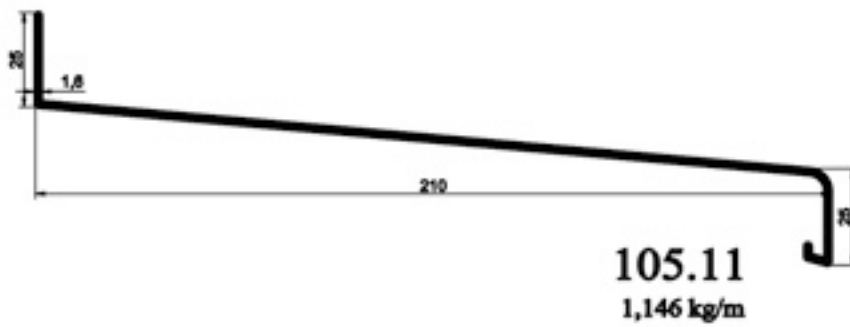
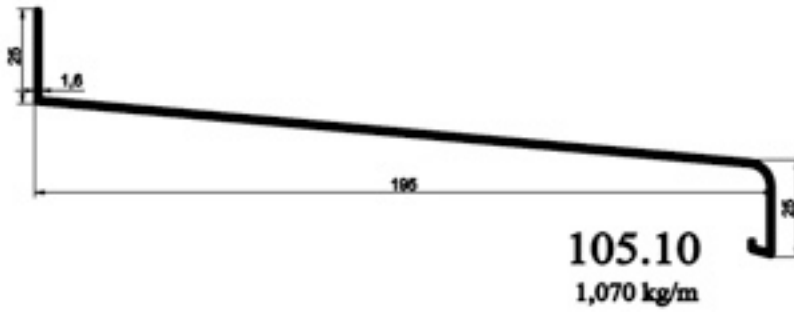
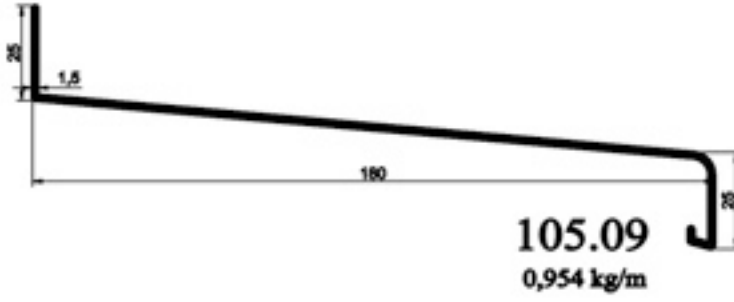
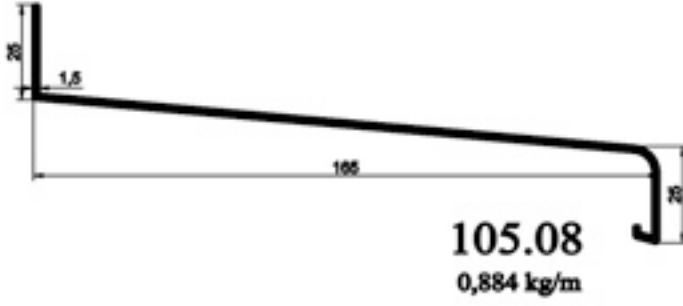

Tüm denizlik profillerinde  $\pm 0.3$  mm kalınlık toleransı vardır.

## DENİZLİKLER 25'LİK 105

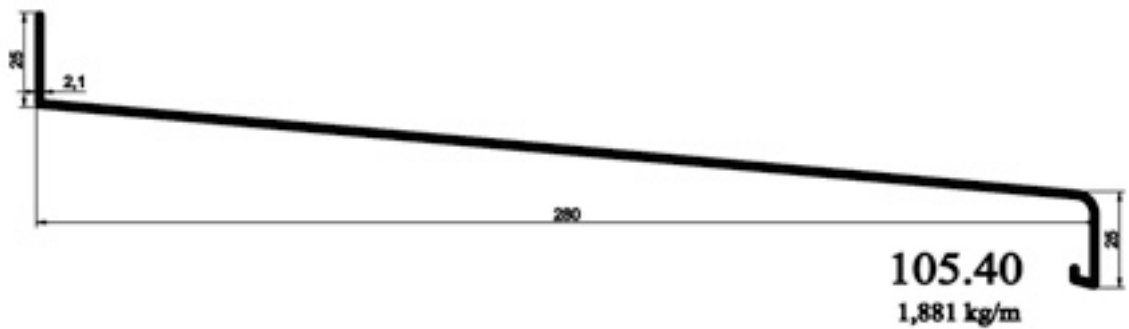
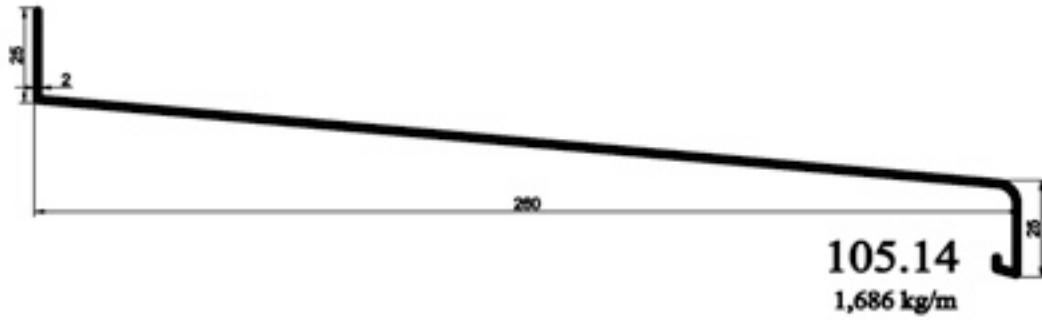
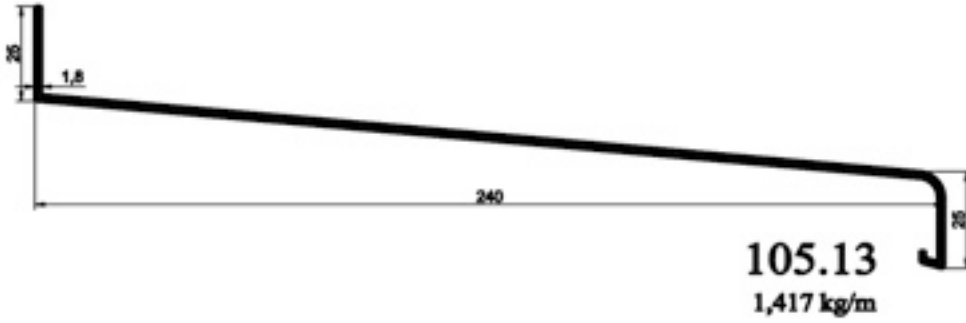
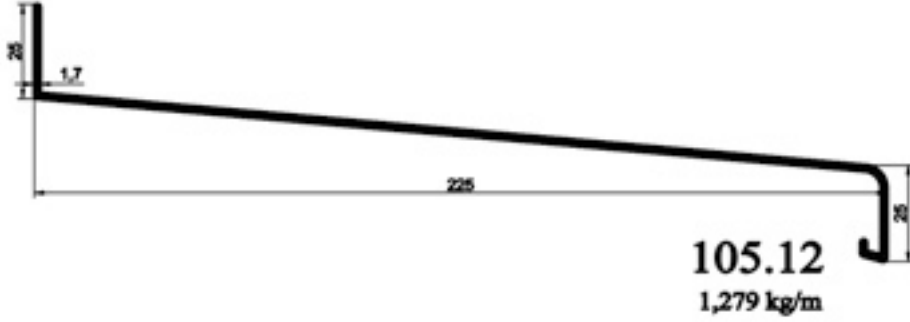

Tüm denizlik profillerinde  $\pm 0.3$  mm kalınlık toleransı vardır.



## DENİZLİKLER 40'LİK 105

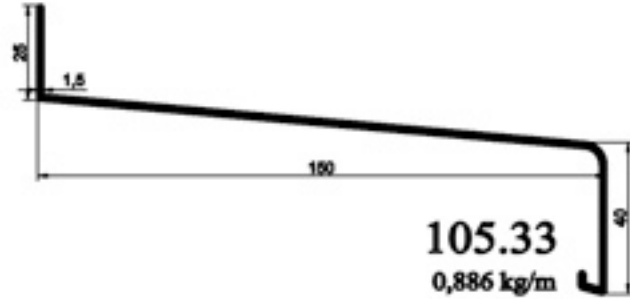
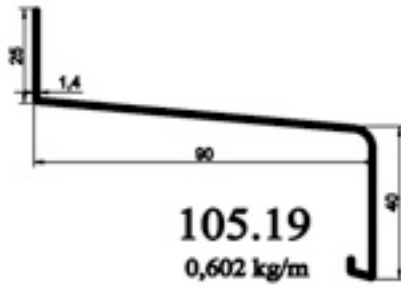
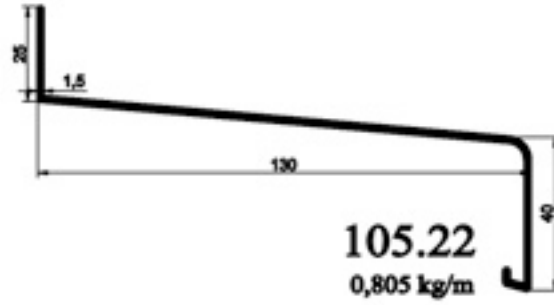
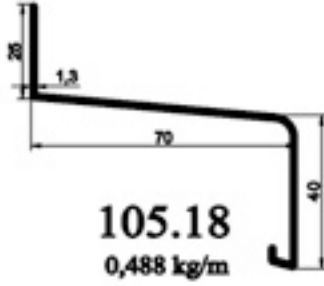
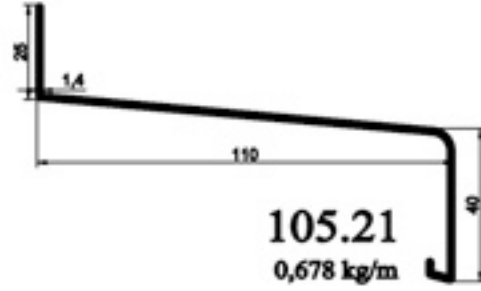
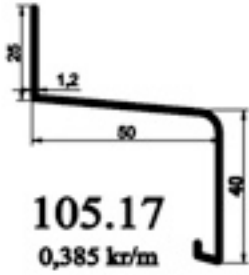

## DENİZLİKLER 40'LİK 105

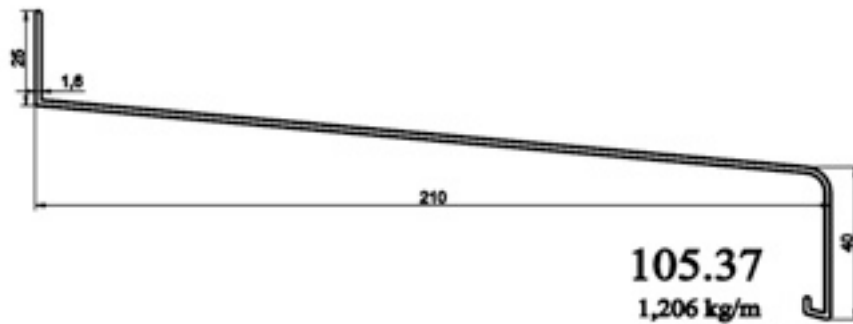
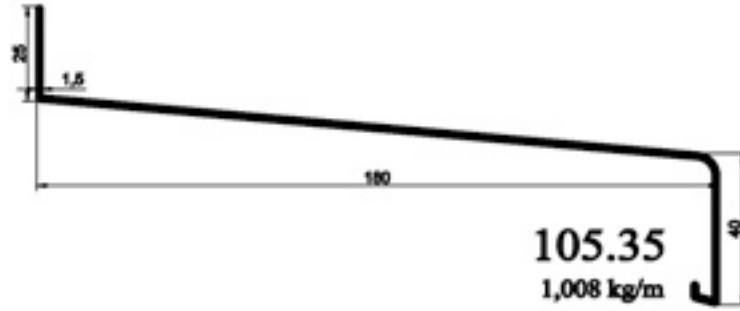
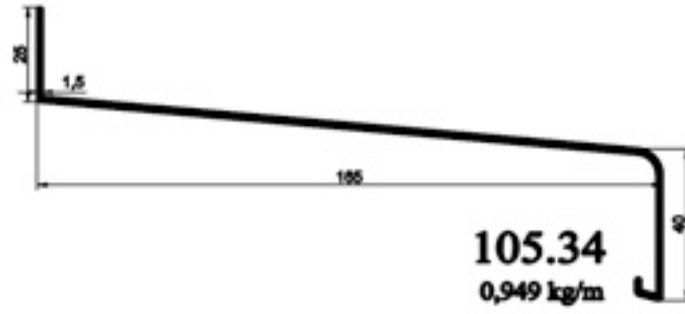

Tüm denizlik profillerinde  $\pm 0.3$  mm kalınlık toleransı vardır.

## DENİZLİKLER 40'LIK 105

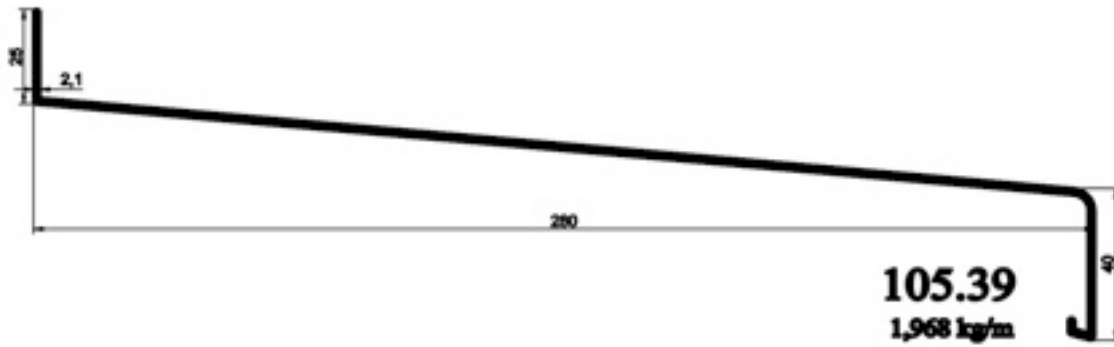
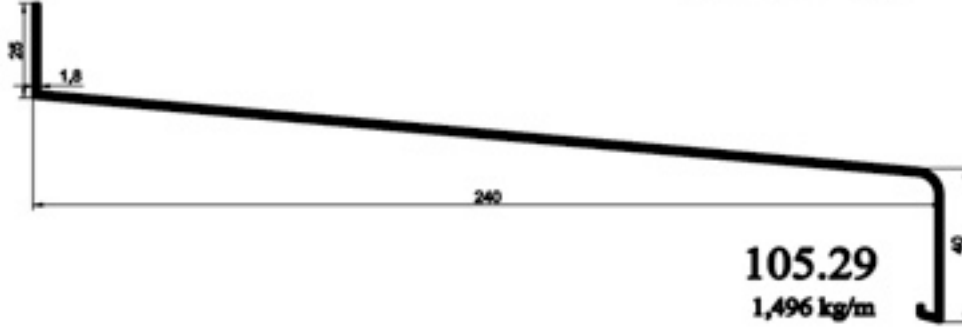
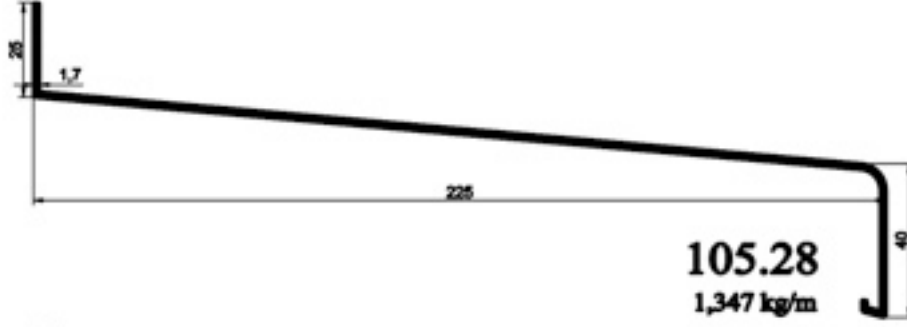

Tüm denizlik profillerinde  $\pm 0.3$  mm kalınlık toleransı vardır.

## GÜNEŞ ENERJİ PROFİLLERİ 106

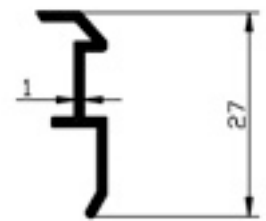
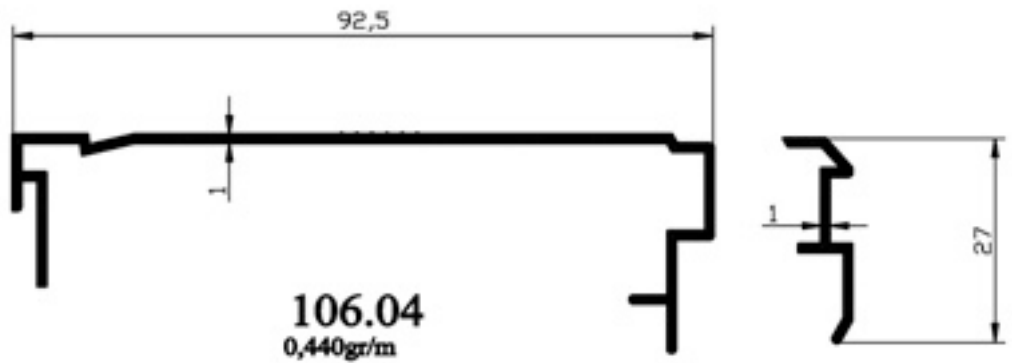
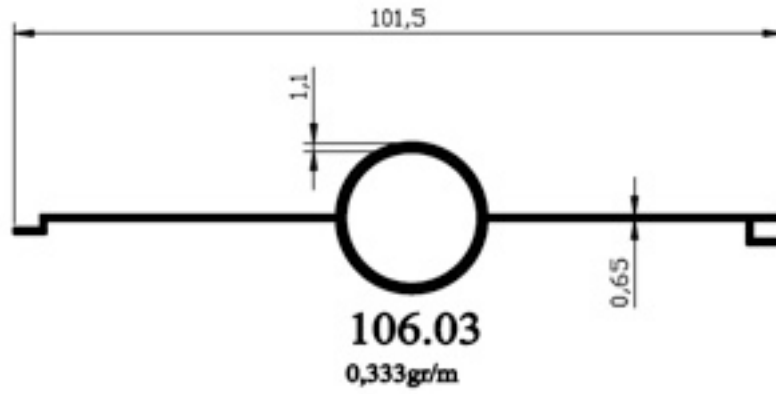
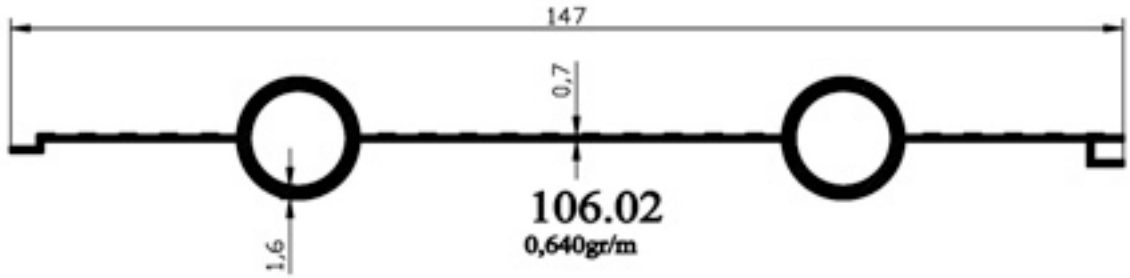
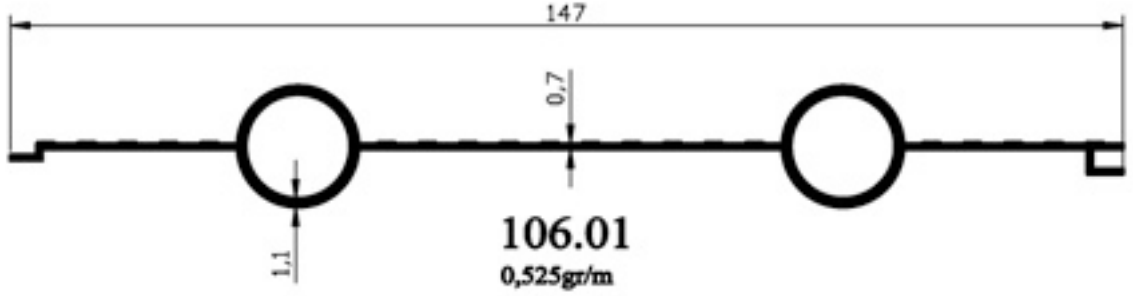

PANJUR PROFİL ve YARDIMCI ELEMANLAR 107

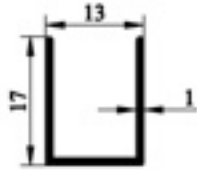

**603.01**  
LAMBRI U SU  
0,121gr/m

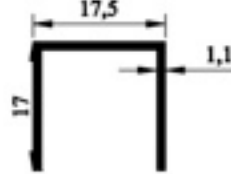

**603.02**  
DAR PANJUR U PROFİLİ  
0,175gr/m

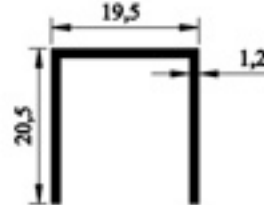

**603.03**  
ASMA TAVAN  
0,320gr/m

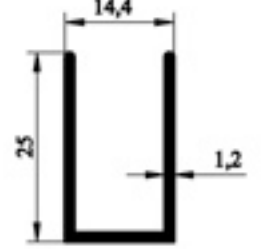

**603.08**  
0,200gr/m

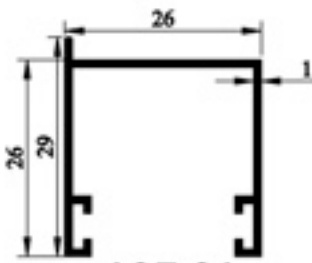

**107.01**  
FİTİLLİ U PROFİLİ  
0,254gr/m

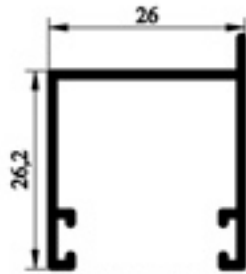

**107.48**  
FİTİLLİ U PROFİLİ  
0,256 gr/m

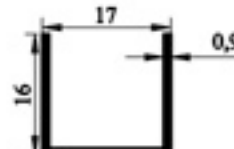

**603.09**  
0,115gr/m

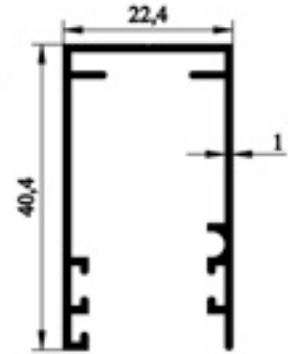

**203.12**  
0,352gr/m

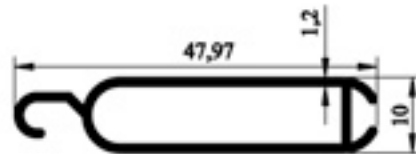

**107.02**  
FİTİLLİ ALT PARÇA  
0,350gr/m

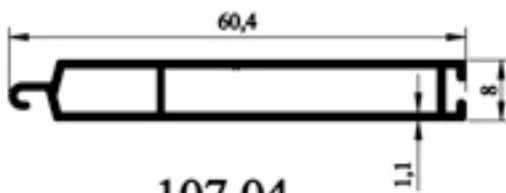

**107.04**  
0,390gr/m

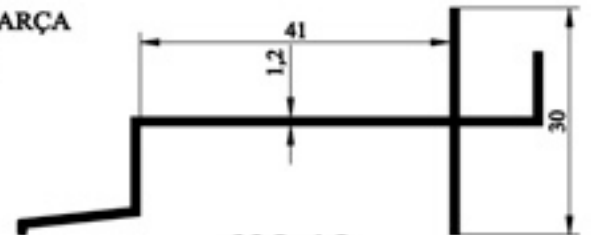

**602.12**  
DENİZLİKLİ T PROFİLİ  
0,390gr/m

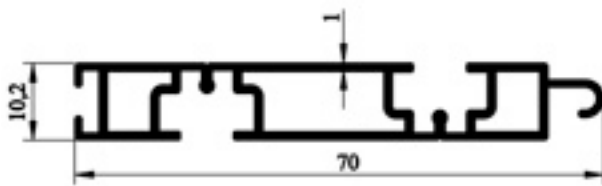

**107.06**  
PANJUR KİLİT PROFİLİ  
0,533gr/m



**107.07**  
PANJUR KİLİT PROFİLİ  
0,367gr/m

## PANJUR PROFİLLERİ 107

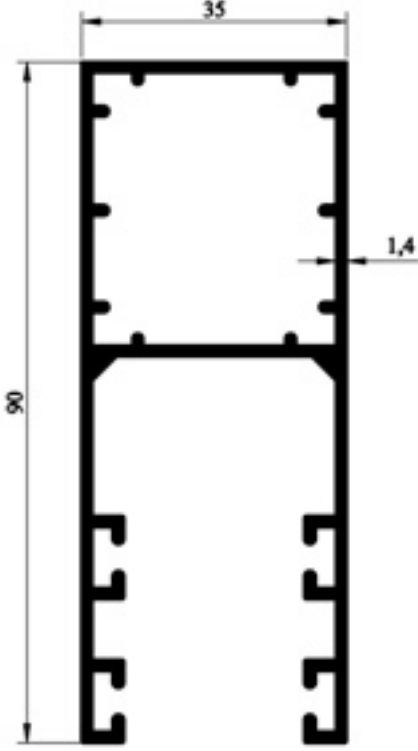

**107.08**

1.227gr/m

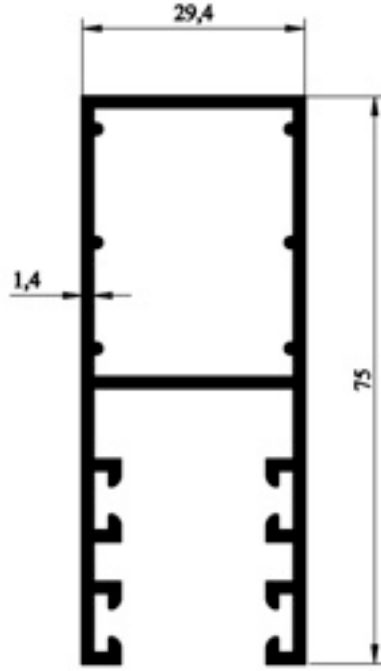

**107.09**

0.958gr/m

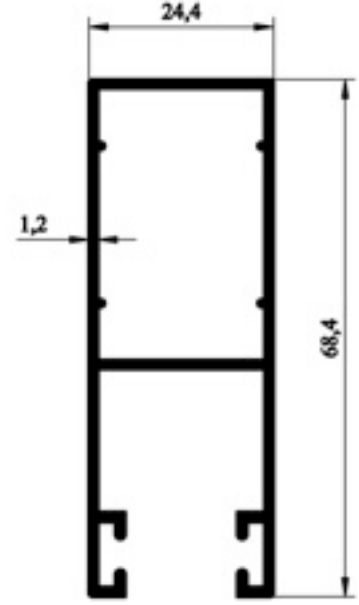

**107.10**

0.677gr/m

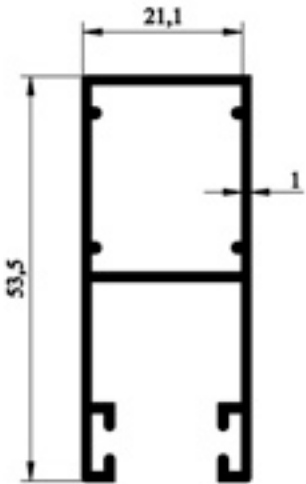

**107.11**

0.477gr/m

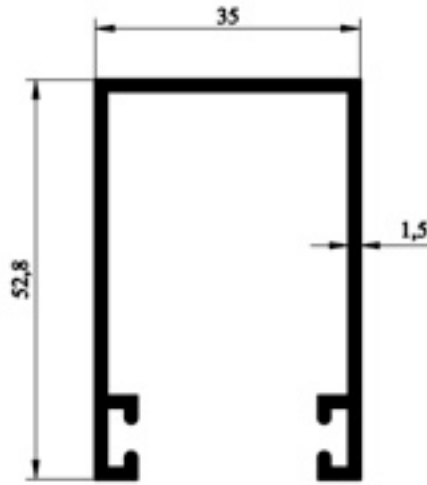

**107.12**

0.655gr/m

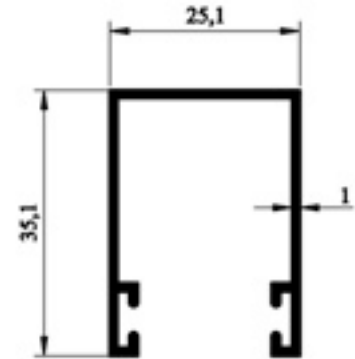

**107.13**

0.307gr/m

PANJUR PROFİLLERİ 107

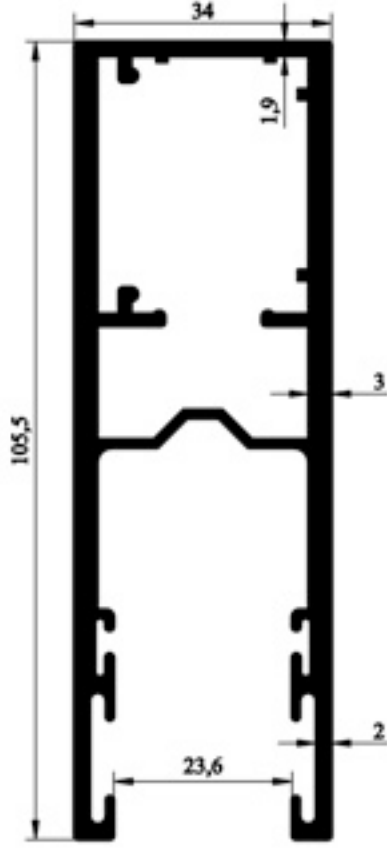

**107.14**  
2.051 gr/m

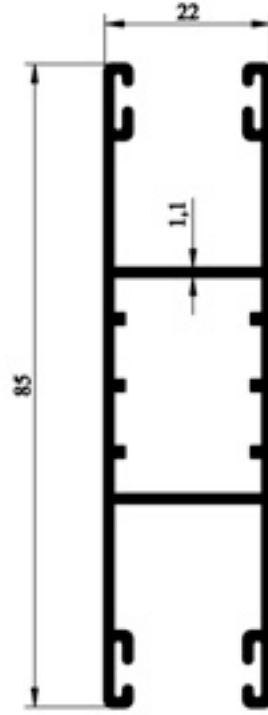

**107.15**  
0.770 gr/m

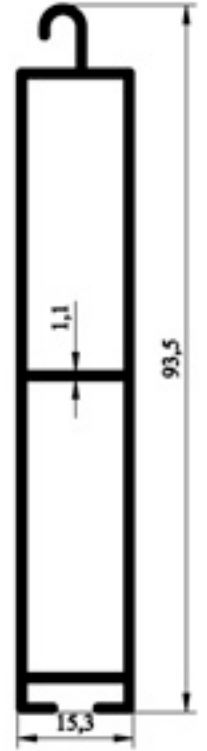

**107.16**  
0.690 gr/m

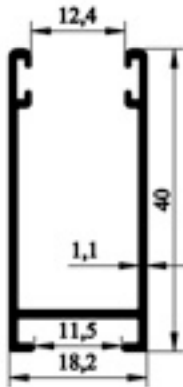

**108.24**  
0.322 gr/m

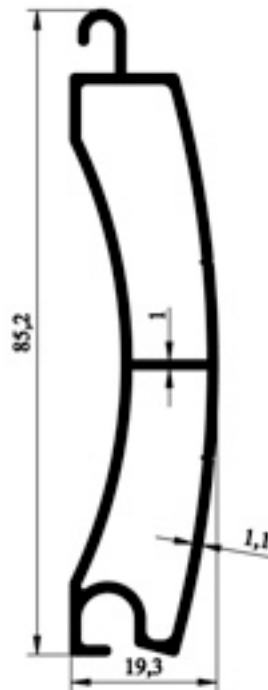

**107.18**  
0.644 gr/m

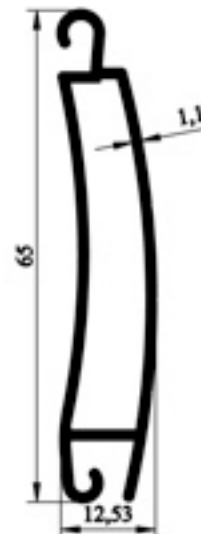

**107.19**  
0.446 gr/m



**107.20**  
0.255 gr/m

## PANJUR PROFİLLERİ 107

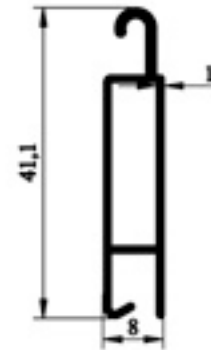
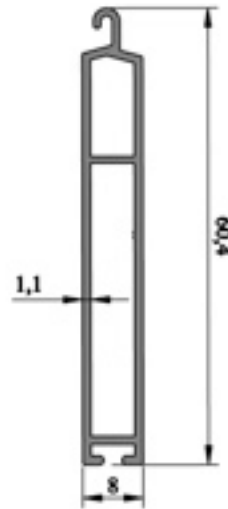
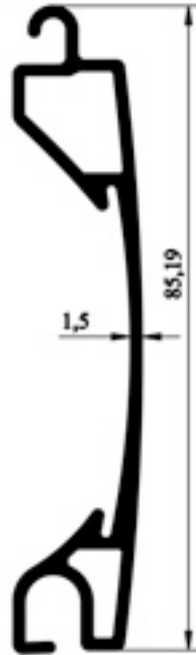
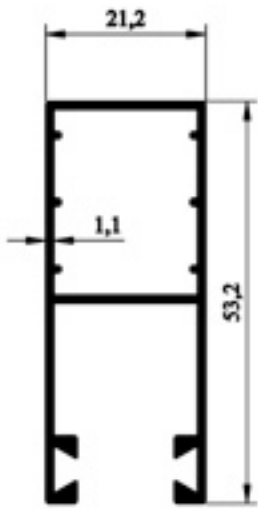
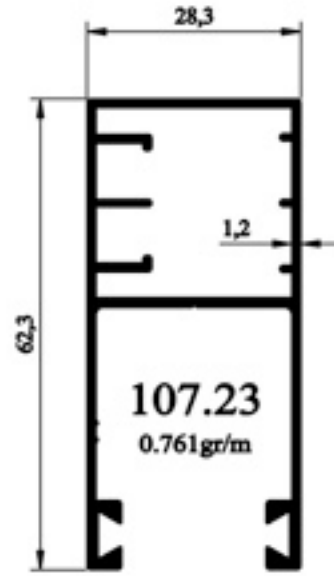
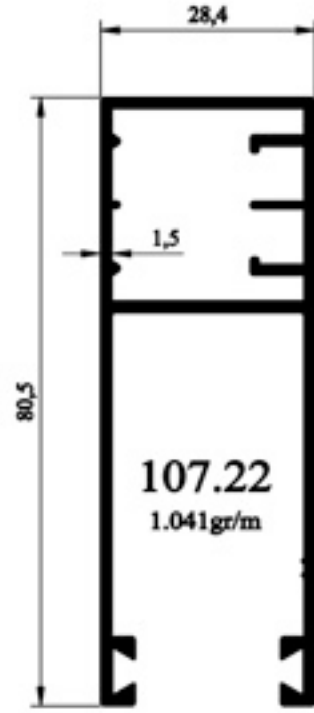
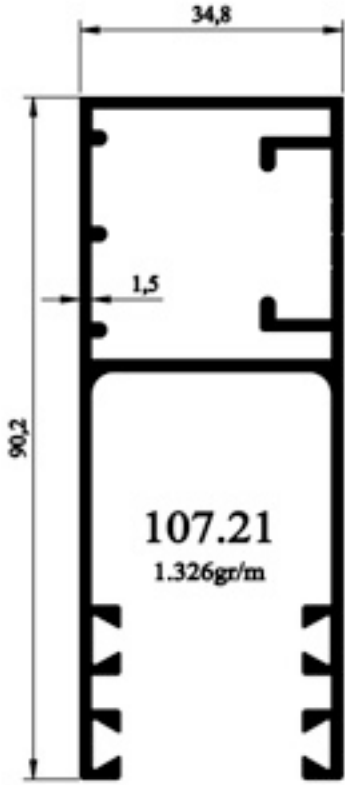



PANJUR PROFİLLERİ 107

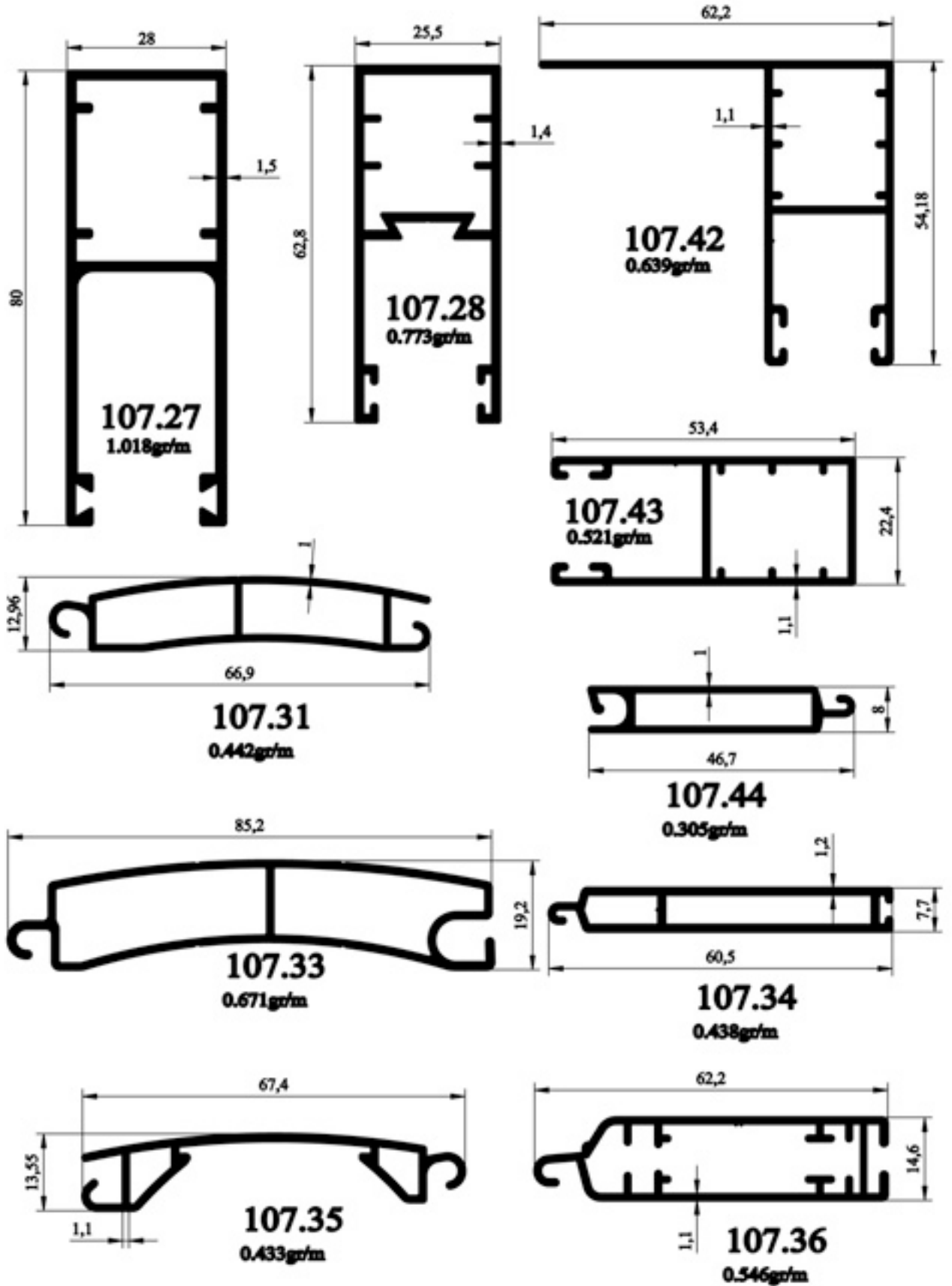

## PANJUR PROFİLLERİ 107

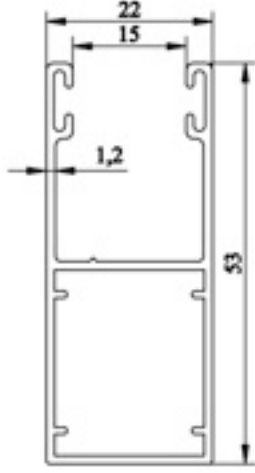

**107.37**  
0.502 grm

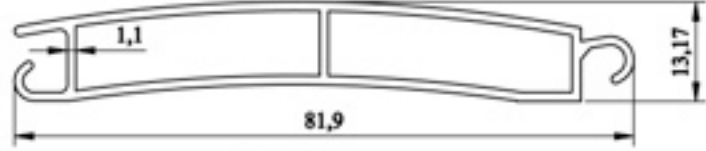

**107.38**  
0.610 grm

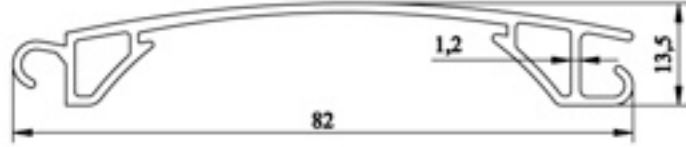

**107.39**  
0.506 grm

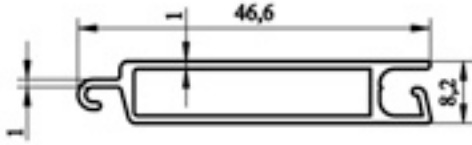

**107.32**  
0.304 grm

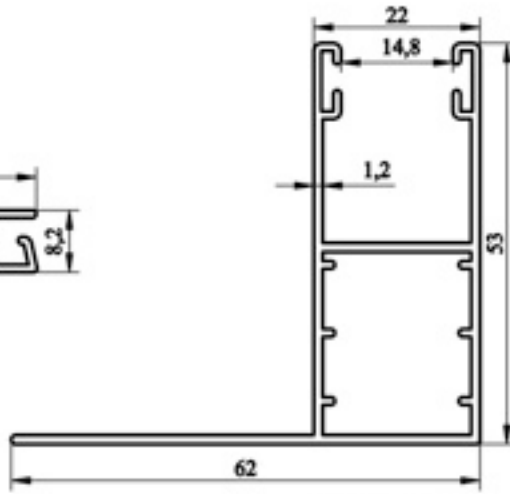

**107.29**  
0.663 grm

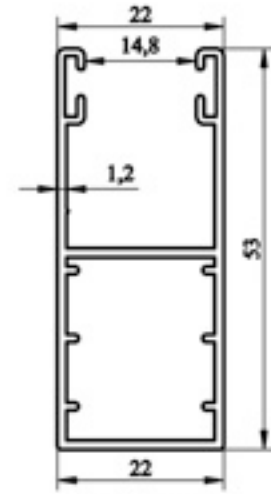

**107.30**  
0.533 grm



**107.40**  
0.321 grm

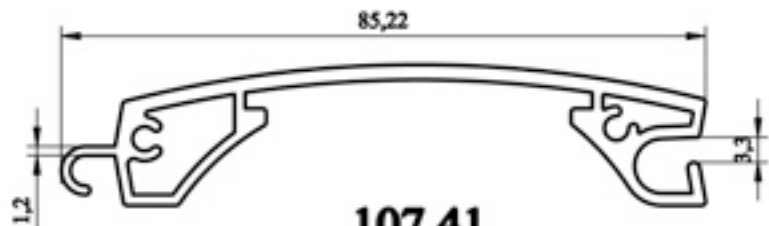

**107.41**  
0.889 grm

## SİNEKLİK PROFİLLERİ 108

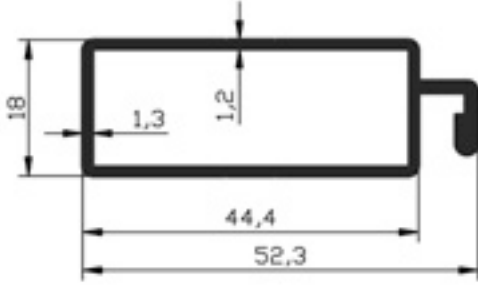

**108.01**  
TEK KULAKLI SİNEKLİK  
0,476gr/m

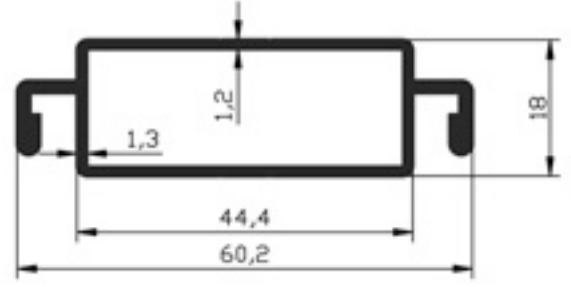

**108.02**  
ÇİFT KULAKLI SİNEKLİK  
0,563gr/m

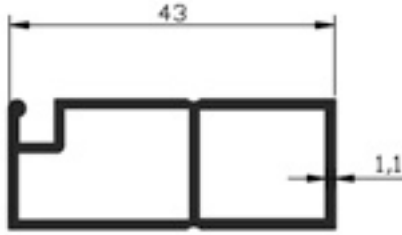

**108.04**  
KAPI SİNEKLİK  
0,404gr/m

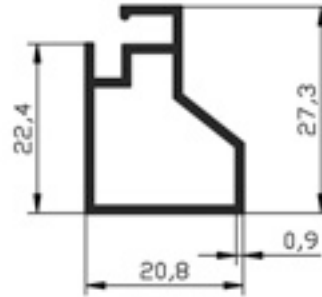

**108.03**  
SİNEKLİK  
0,233gr/m

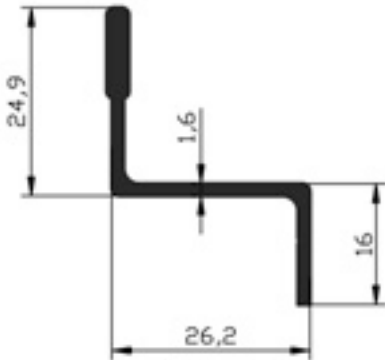

**108.07**  
S. SİNEKLİK RAY  
0.330 gr/m

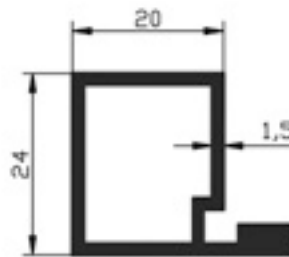

**108.08**  
0.425gr/m

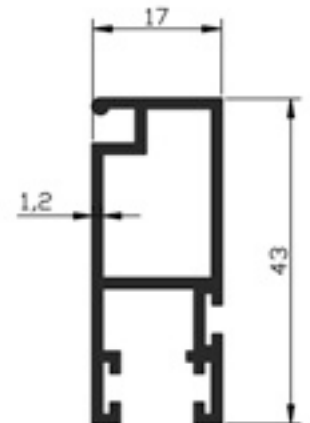

**108.09**  
SÜRME SİNEKLİK  
0.460 gr/m

## STOR SİNEKLİK PROFİLLERİ 108

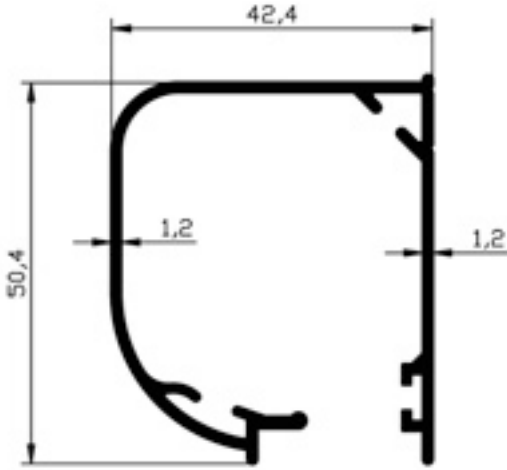

**108.10**  
STOR KASA  
0.598gt/m

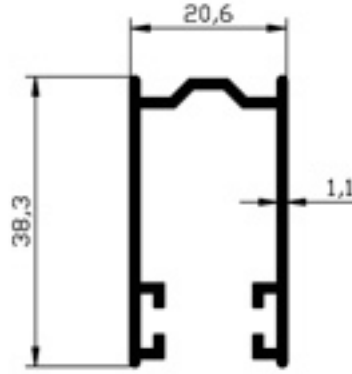

**108.11**  
STOR U PROFİLİ  
0.348gt/m

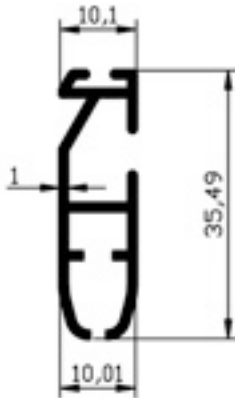

**108.12**  
STOR ALT PARÇA  
0.251gt/m

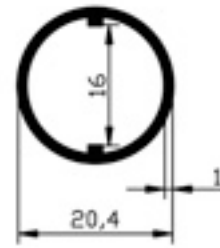

**108.13**  
STOR OVAL BORU  
0.176gt/m

## STOR SİNEKLİK PROFİLLERİ 108

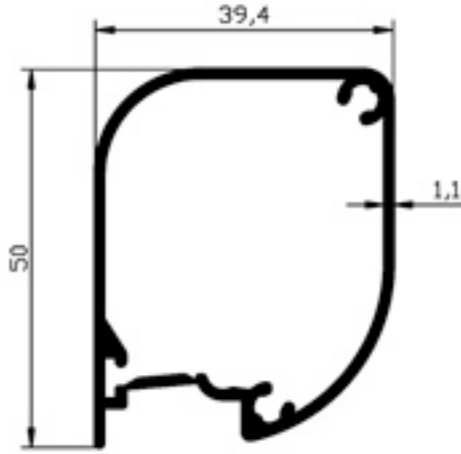

**108.14**  
0.573gr/m  
STOR KASA



**108.15**  
0.237gr/m  
STOR OVAL BORU

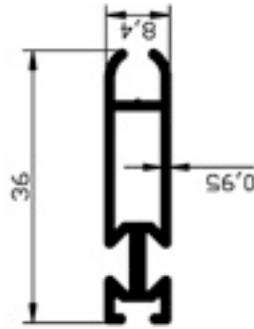

**108.16**  
0.275gr/m  
STOR ALT PARÇA

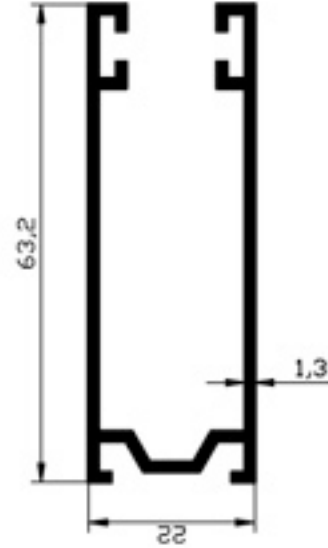

**108.17**  
0.625gr/m  
STOR U PROFİLİ

## STOR SİNEKLİK PROFİLLERİ 108

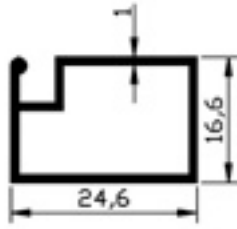

**108.22**  
0,232 gr/m

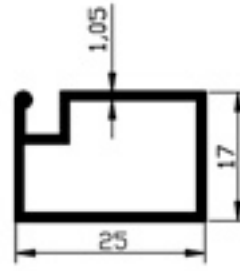

**108.05**  
0,260 gr/m

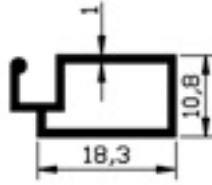

**108.23**  
0,167 gr/m

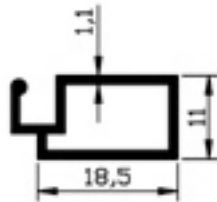

**108.06**  
0,200 gr/m

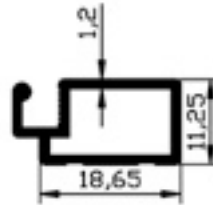

**108.18**  
0,209 gr/m

## MOBİLYA PROFİLLERİ 201

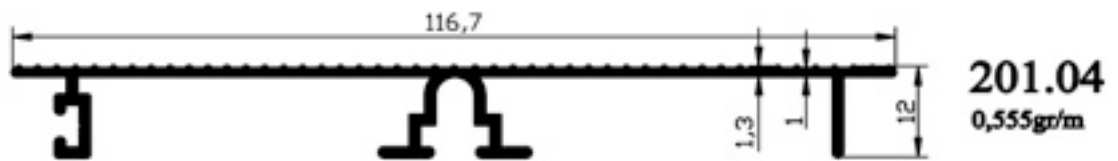
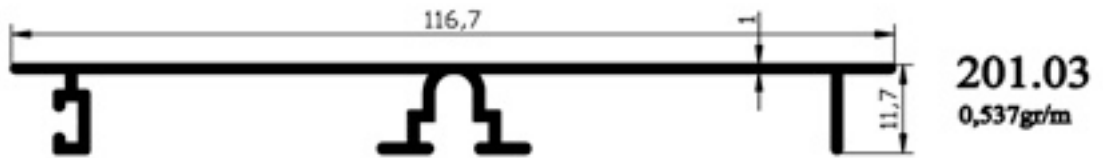
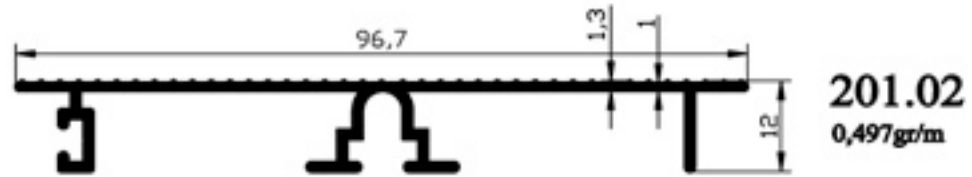

## MOBİLYA PROFİLLERİ 201

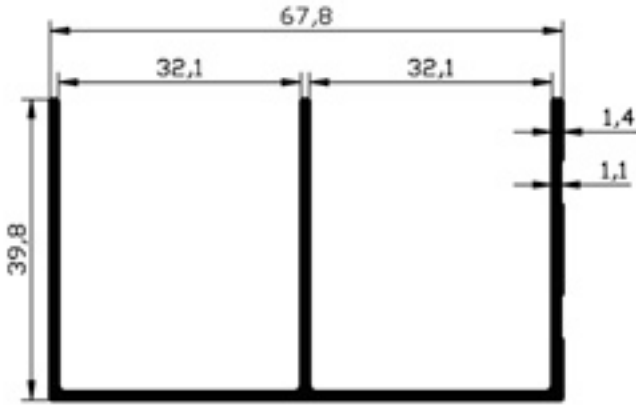

**201.05**  
0,571gr/m

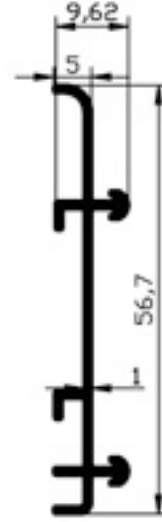

**201.06**  
0,270gr/m

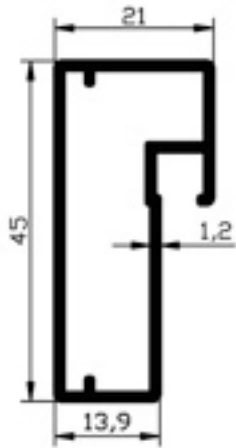

**201.07**  
0,450gr/m

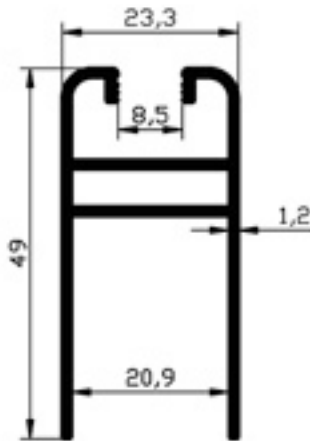

**201.08**  
0,509gr/m

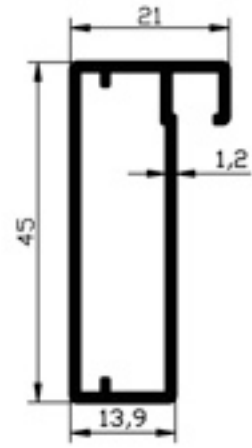

**201.09**  
0,425gr/m



## MOBİLYA PROFİLLERİ 201

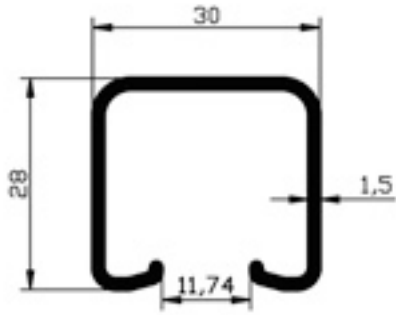

**201.18**  
0.380gr/m  
RAY

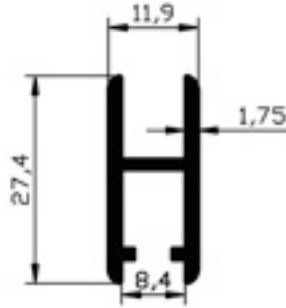

**201.19**  
0.297gr/m  
H PROFİLİ

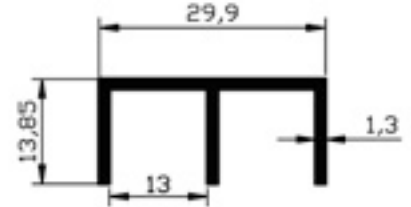

**201.20**  
0.237gr/m  
B PROFİLİ

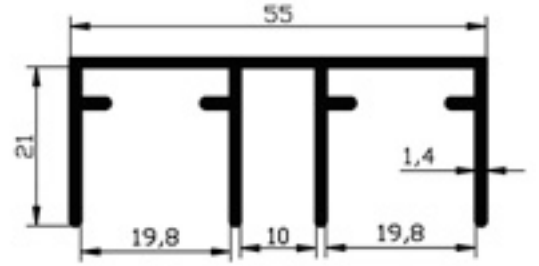

**201.37**  
0.526gr/m

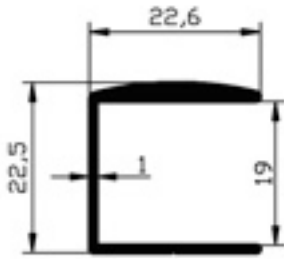

**201.21**  
0.235gr/m

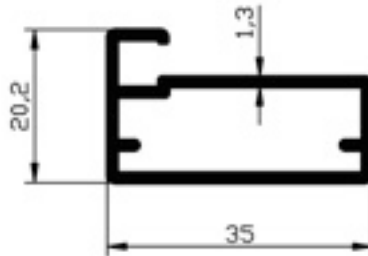

**201.22**  
0.395gr/m

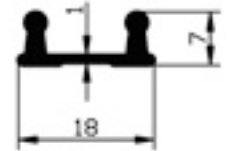

**201.23**  
0.126gr/m  
RAY PROFİLİ



**201.24**  
0.276gr/m

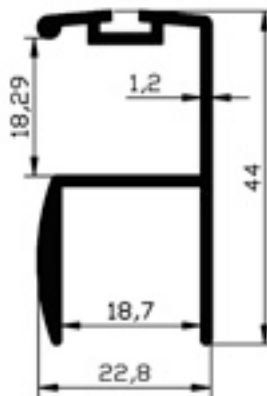

**201.25**  
0.442gr/m

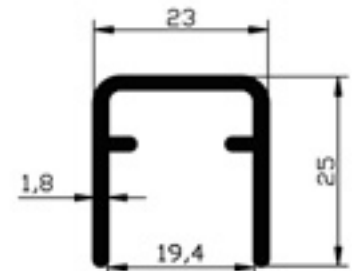

**201.26**  
0.345gr/m

## MOBİLYA PROFİLLERİ 201

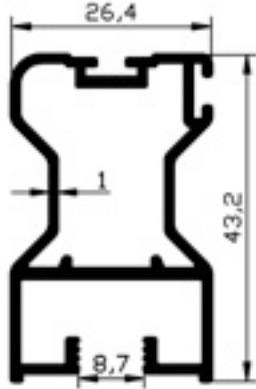

**201.10**  
0,527gr/m

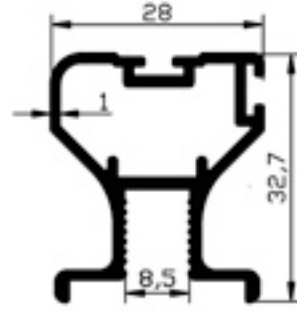

**201.11**  
0,438gr/m

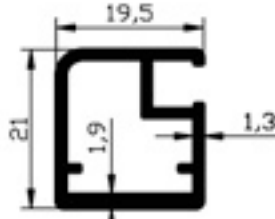

**201.12**  
0,324gr/m

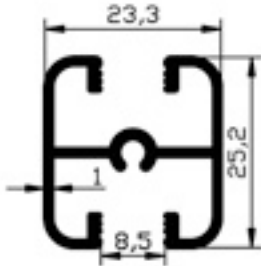

**201.13**  
0,322gr/m

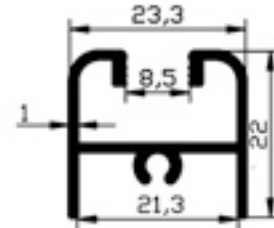

**201.14**  
0,258gr/m

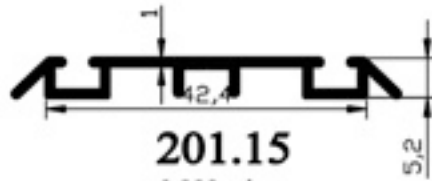

**201.15**  
0,233gr/m

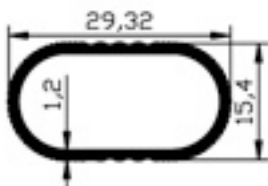

**201.16**  
0,211gr/m

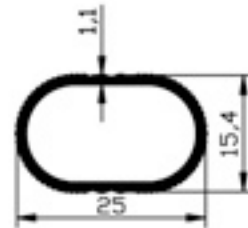

**201.17**  
0,170gr/m

## MOBİLYA PROFİLLERİ 201

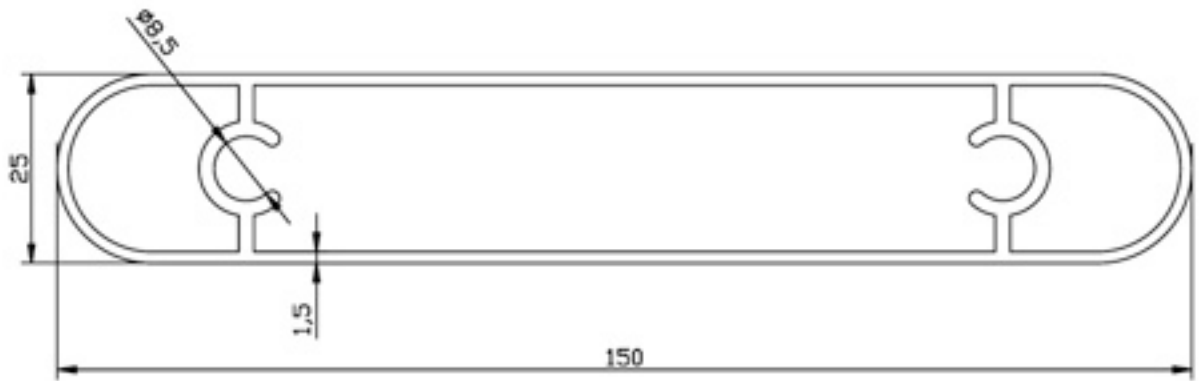
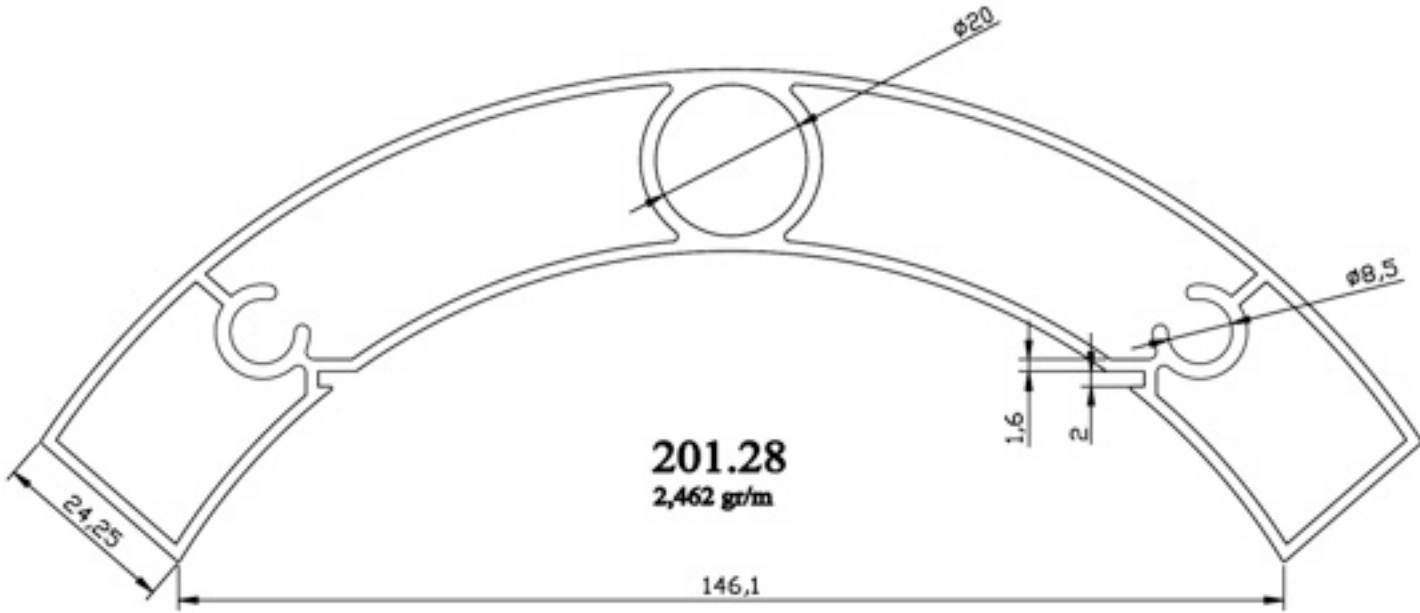

**201.29**  
1,612 gr/m

## MOBİLYA PROFİLLERİ 201

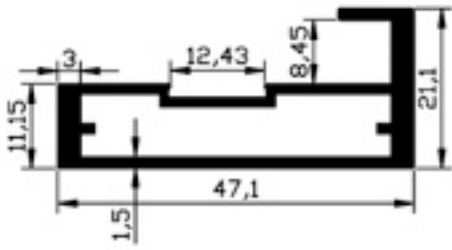

**201,30**  
0,621 gr/m

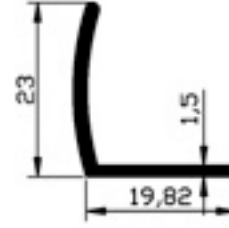

**201,35**  
0,183 gr/m

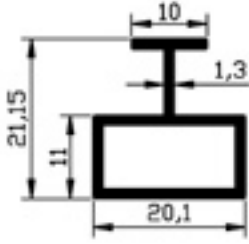

**201,31**  
0,267 gr/m



**201,36**  
0,340 gr/m

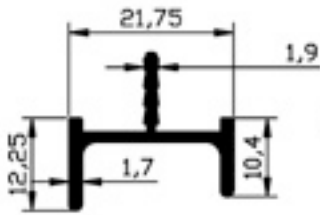

**201,32**  
0,213 gr/m

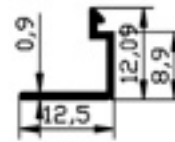

**201,34**  
0,062 gr/m

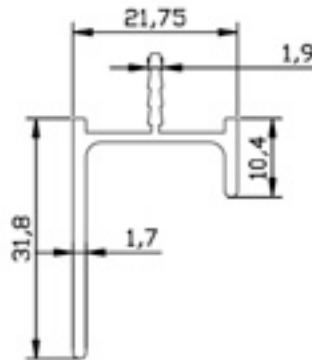

**201,33**  
0,302 gr/m

## MOBİLYA PROFİLLERİ 201

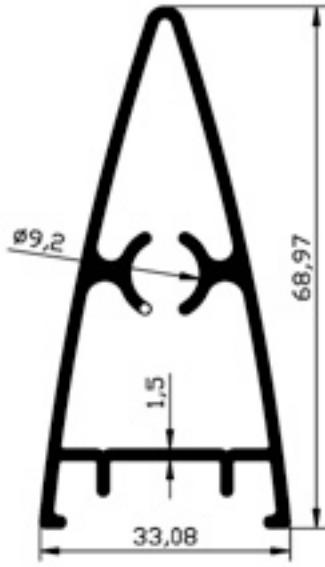

**201,45**  
0,916 gr/m

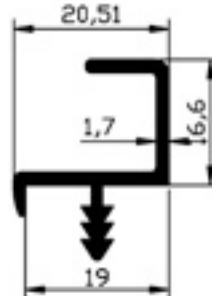

**201,46**  
0,279 gr/m



**201,47**  
0,165 gr/m

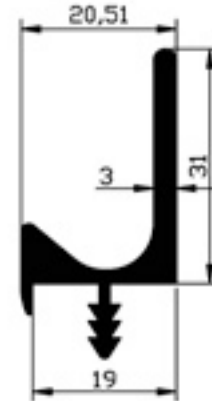

**201,48**  
0,518 gr/m

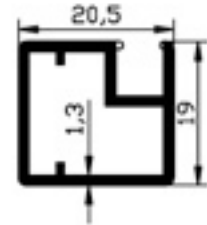

**201,49**  
0,295 gr/m

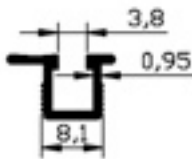

**201,56**  
0,091 gr/m

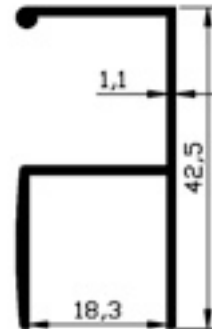

**201,57**  
0,331 gr/m

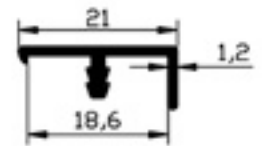

**201,58**  
0,115 gr/m

## MOBİLYA PROFİLLERİ 201



**201,79**  
0,106 gr/m

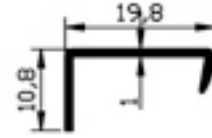

**201,80**  
0,095 gr/m

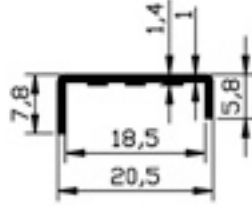

**201,81**  
0,095 gr/m

## ARTEMİS DUŞAKABİN 202

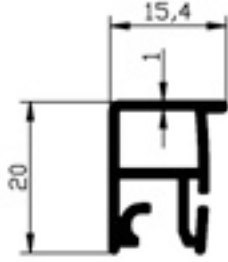

**202.01**  
0,225gr/m

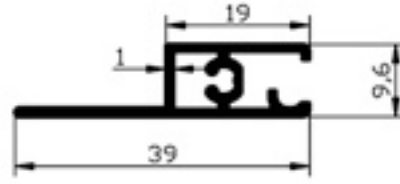

**202.02**  
0,245gr/m

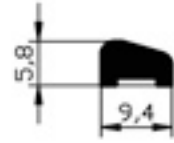

**202.03**  
0,113gr/m

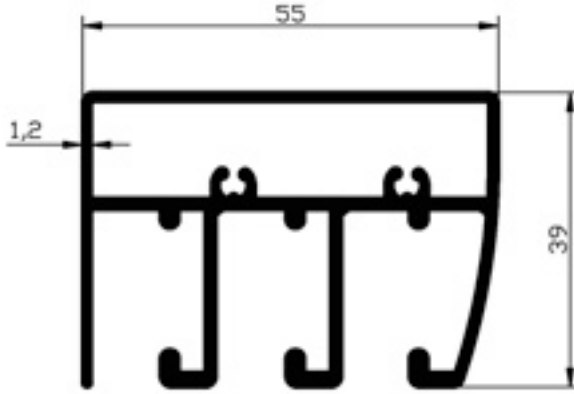

**202.04**  
1,093gr/m

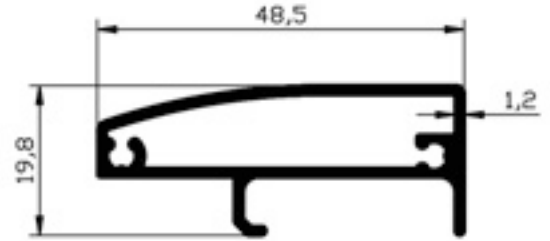

**202.05**  
0,474gr/m

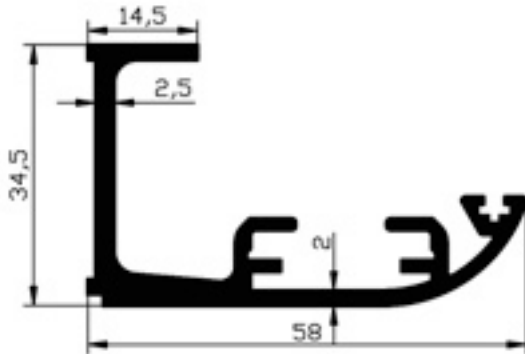

**202.06**  
0,889gr/m

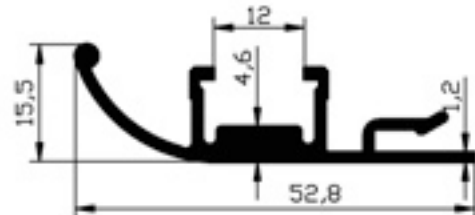

**202.07**  
0,450gr/m

## ARTEMİS DUŞAKABİN 202

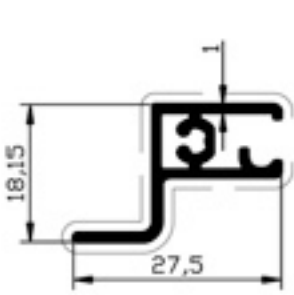

**202.08**  
0,229gr/m

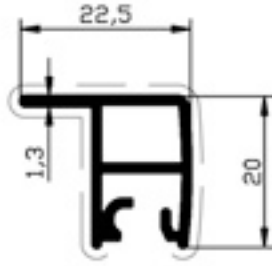

**202.09**  
0,240gr/m

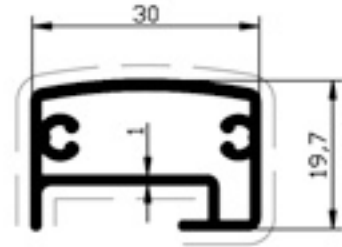

**202.10**  
0,357gr/m

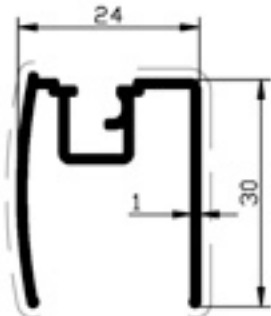

**202.11**  
0,285gr/m

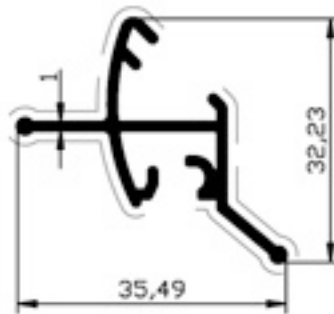

**202.12**  
0,277gr/m

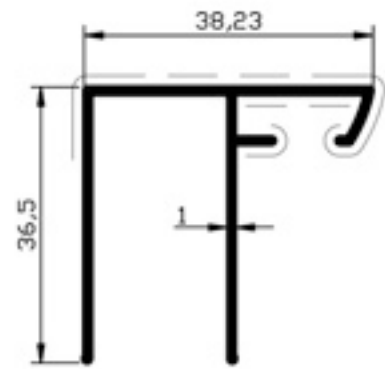

**202.13**  
0,333gr/m



BELLA DUŞAKABİN 202

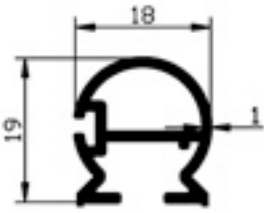

**202.21**  
0.221gr/m

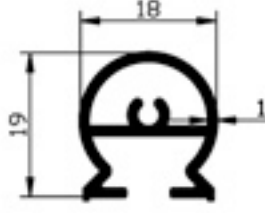

**202.22**  
0.263gr/m

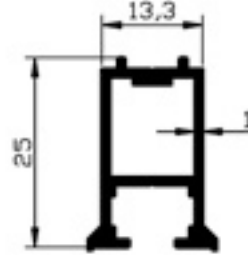

**202.23**  
0.248gr/m

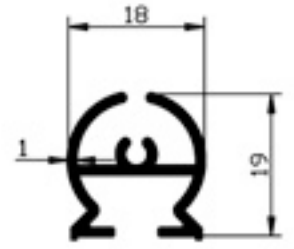

**202.24**  
0.255gr/m

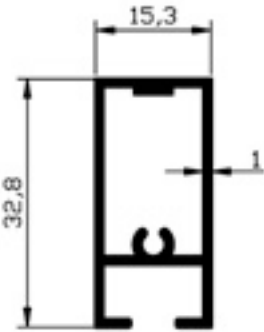

**202.25**  
0.341gr/m

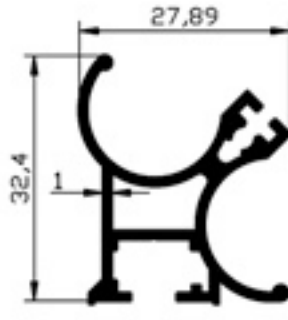

**202.26**  
0.440gr/m

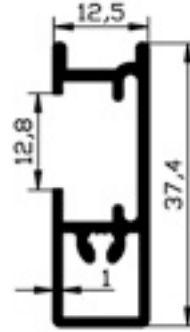

**202.27**  
0.322gr/m

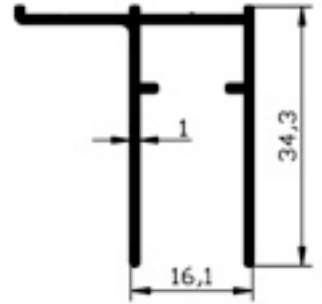

**202.28**  
0.296gr/m

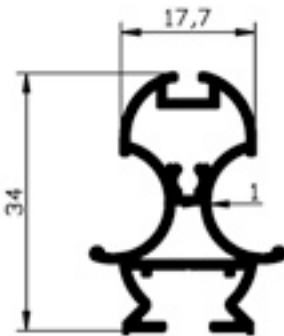

**202.29**  
0.490gr/m

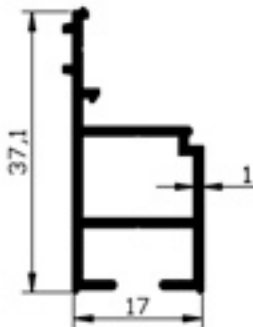

**202.30**  
0,280 Kg/m

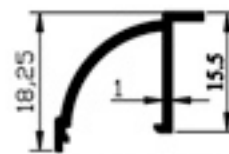

**202.31**  
0,122 Kg/m

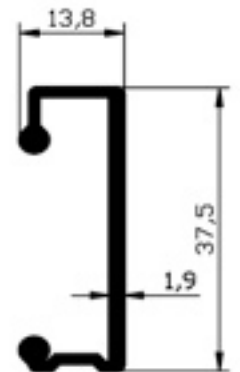

**202.32**  
0.335gr/m

## BELLA DUŞAKABİN 202

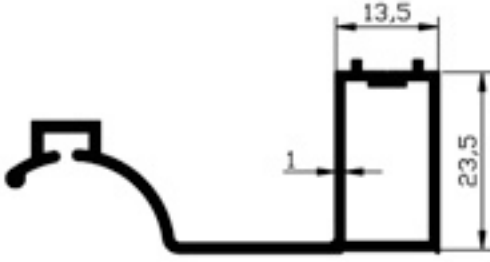

**202.33**  
0.417gr/m

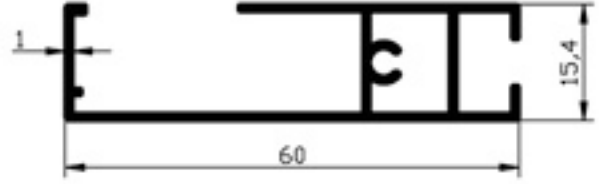

**202.34**  
0.463gr/m

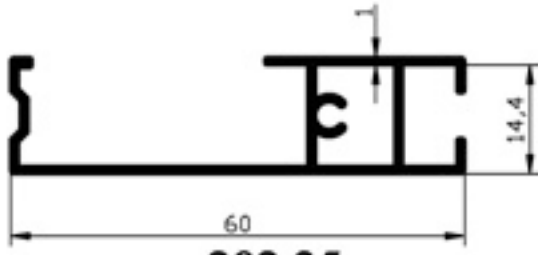

**202.35**  
0.470gr/m

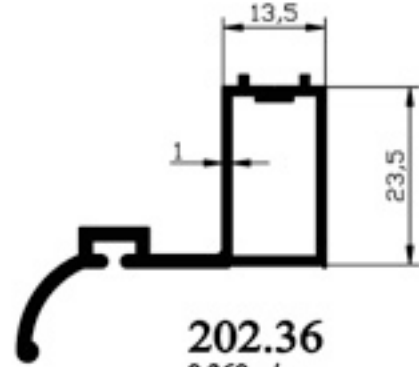

**202.36**  
0.360gr/m

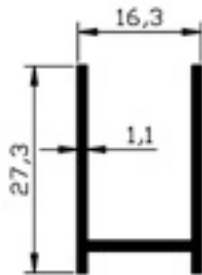

**202.37**  
0.210 Kg/m

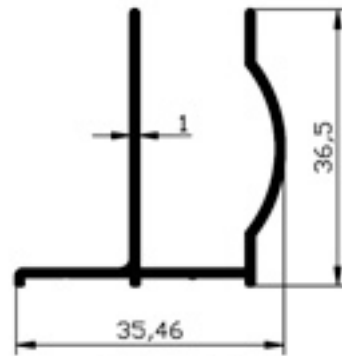

**202.38**  
0.286 Kg/m

## DUŞAKABİN FİTİLLİ ve ÜÇLÜ KAYAR SERİ 202

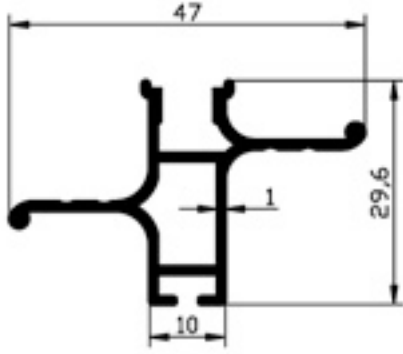

**202.41**  
**0.370 Kg/m**

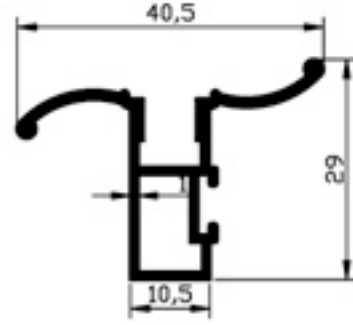

**202.42**  
**0.340 Kg/m**

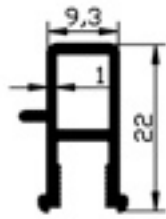

**202.43**  
**0.192 Kg/m**

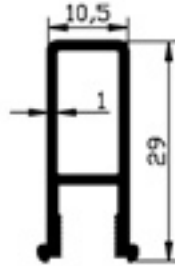

**202.44**  
**0.265 Kg/m**

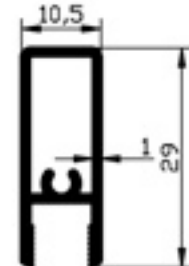

**202.45**  
**0.230 Kg/m**

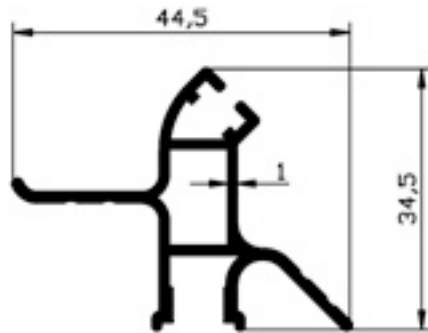

**202.46**  
**0.385 Kg/m**

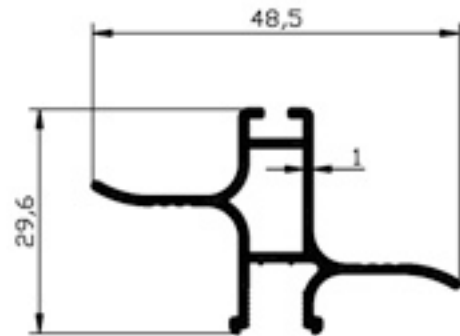

**202.47**  
**0.325 Kg/m**

## DUŞAKABİN KING FITİLLİ SERİ 202



**202.44**  
0.265 Kg/m

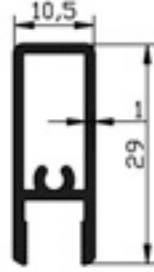

**202.45**  
0.230 Kg/m

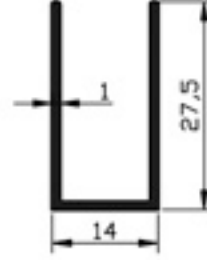

**603.08**  
0.200 Kg/m

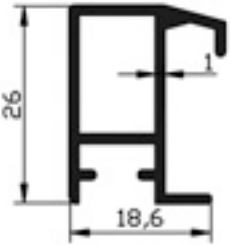

**202.53**  
0.266 Kg/m

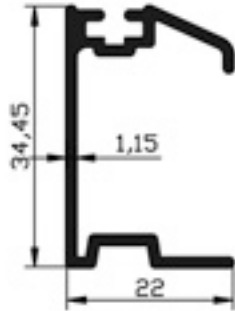

**202.54**  
0.309 Kg/m

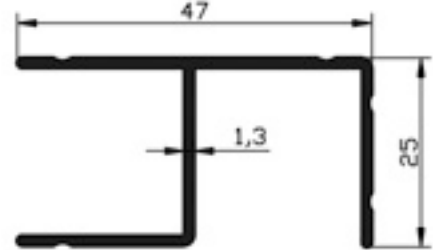

**202.55**  
0.396 Kg/m

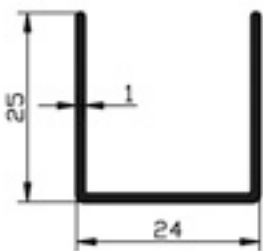

**603.07**  
0.195 Kg/m

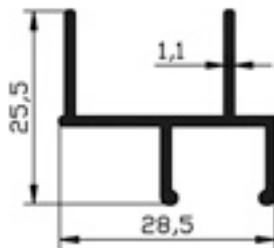

**202.57**  
0.232 Kg/m

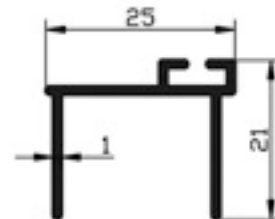

**202.58**  
0.220 Kg/m

## DUŞAKABİN KING FİTİLLİ SERİ 202

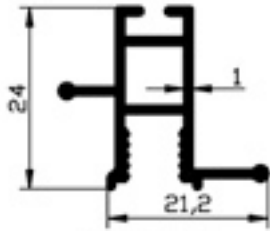

**202.59**  
0.260 Kg/m

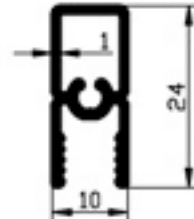

**202.60**  
0.214 Kg/m

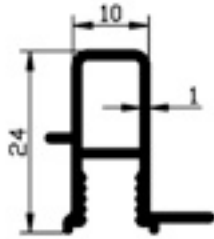

**202.61**  
0.221 Kg/m

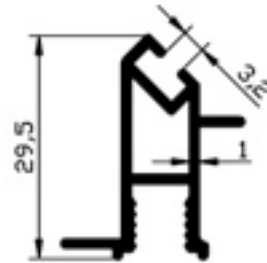

**202.62**  
0.269 Kg/m

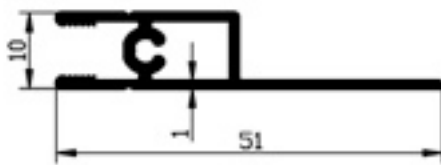

**202.63**  
0.284 Kg/m

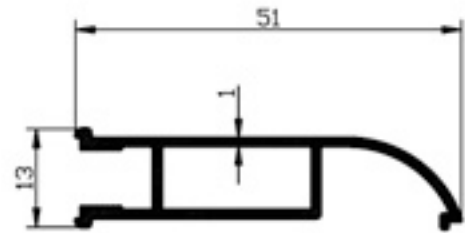

**202.64**  
0,309gr/m

DUŞAKABİN KING SLİKONLU SERİ 202

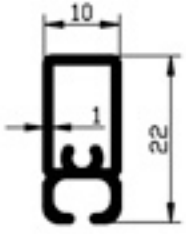

**202.71**  
0.198 Kg/m

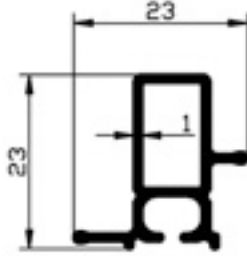

**202.72**  
0.233 Kg/m

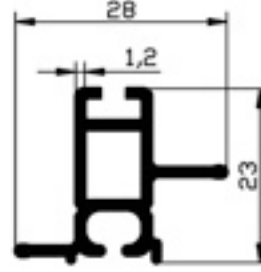

**202.73**  
0.298 Kg/m

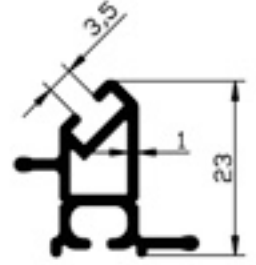

**202.74**  
0.244 Kg/m

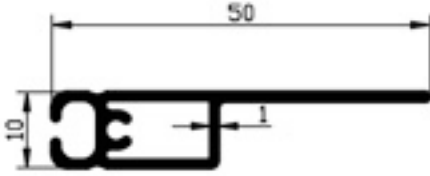

**202.75**  
0.288 Kg/m

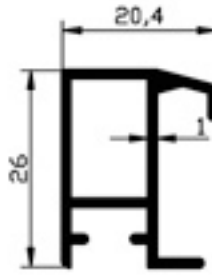

**202.53**  
0.266 Kg/m

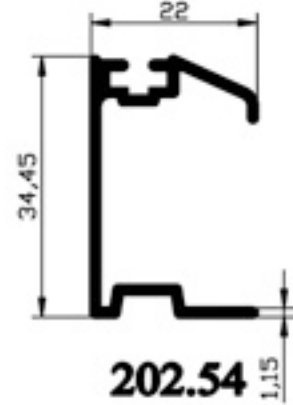

**202.54**  
0.309 Kg/m

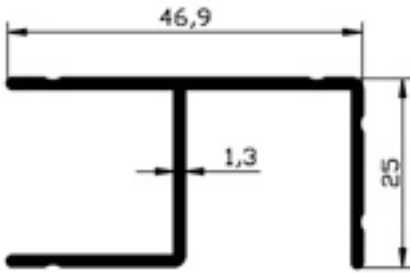

**202.55**  
0.396 Kg/m

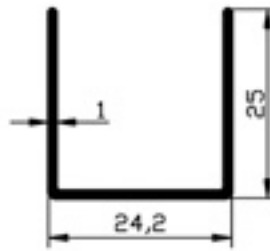

**603.07**  
0.195 Kg/m

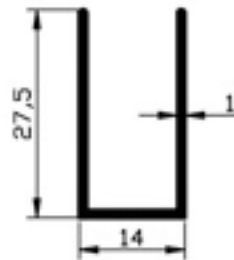

**603.08**  
0.200 Kg/m

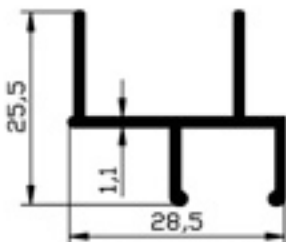

**202.57**  
0.232 Kg/m

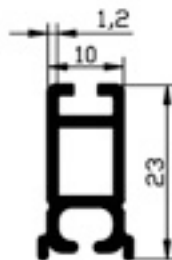

**202.82**  
0.239 Kg/m

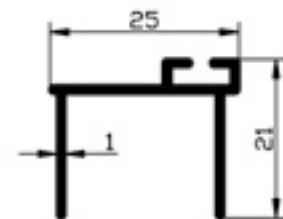

**202.58**  
0.220 Kg/m

## RELAX PROFİLLERİ 202

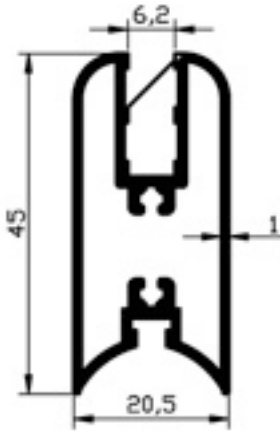

**202.91**  
0.560 Kg/m

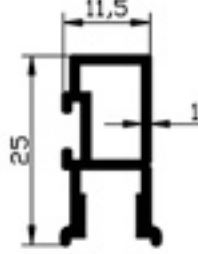

**202.92**  
0.225 Kg/m

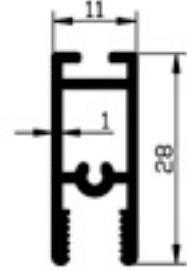

**202.93**  
0.260 Kg/m



**202.94**  
0.236 Kg/m

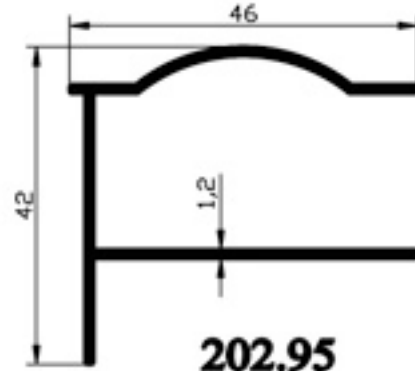

**202.95**  
0.410 Kg/m

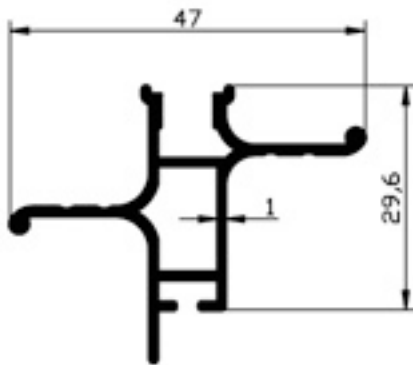

**202.97**  
0.390 Kg/m

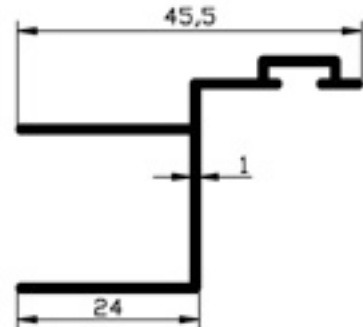

**202.96**  
0.290 Kg/m

## MENFEZ HAVALANDIRMA ve JALUZİ PROFİLLERİ 203

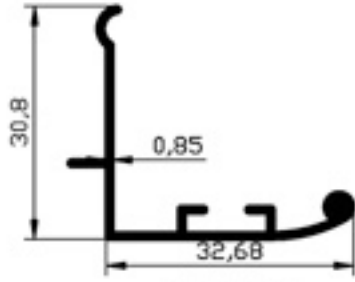

**203.01**  
0,215 gr/m

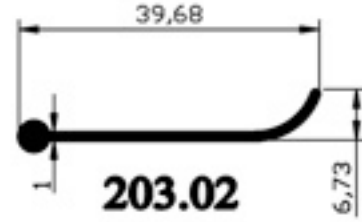

**203.02**  
0,137 gr/m

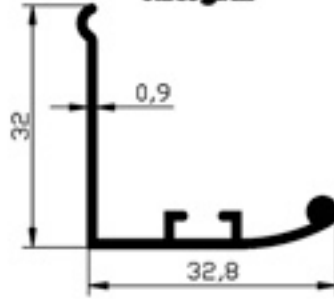

**203.03**  
0,210 Kg/m

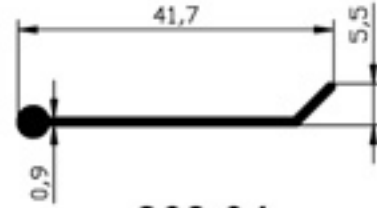

**203.04**  
0,130 Kg/m

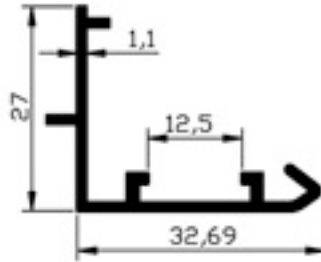

**203.05**  
0,245 Kg/m

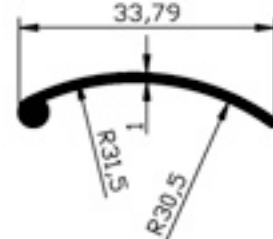

**203.06**  
0,120 Kg/m

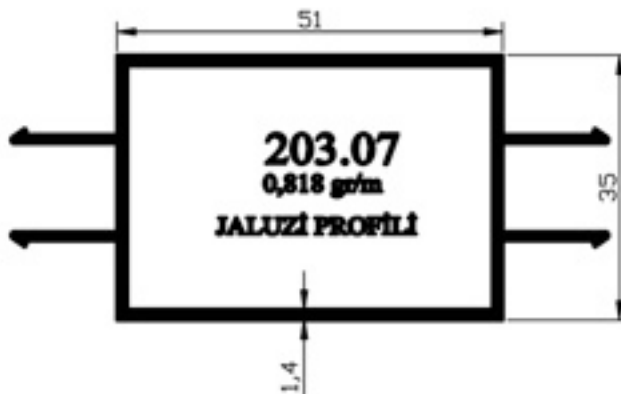

**203.07**  
0,818 gr/m  
JALUZİ PROFİLİ

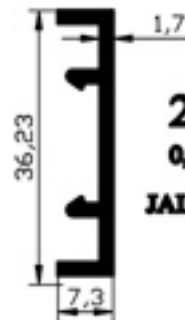

**203.08**  
0,255 gr/m  
JALUZİ KAPAK



## MENFEZ ve RAY PROFİLLERİ 203

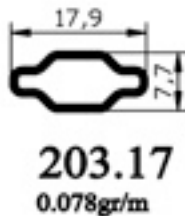
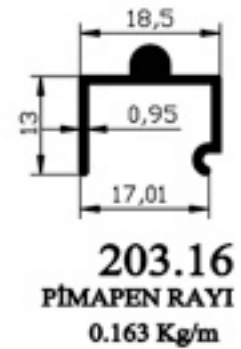
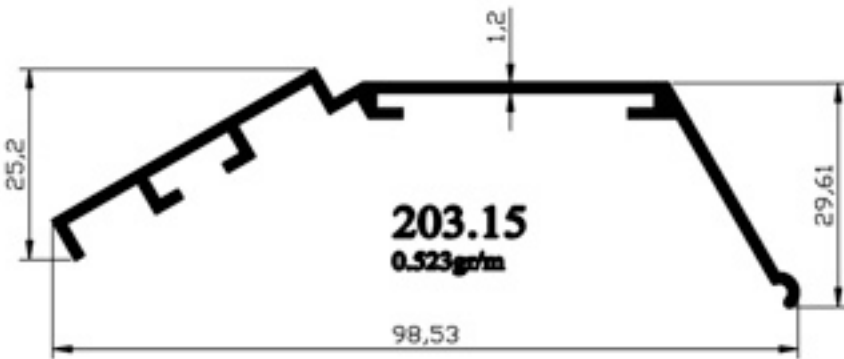
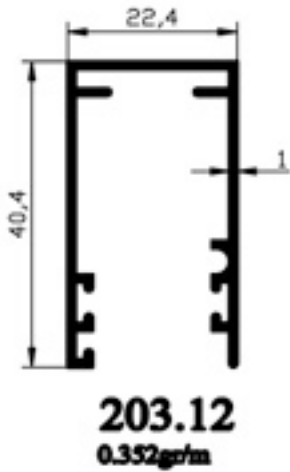
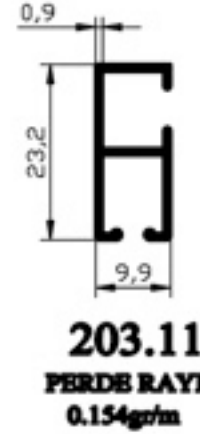
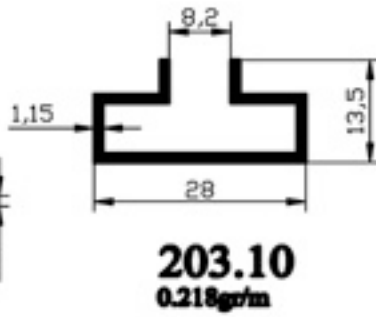
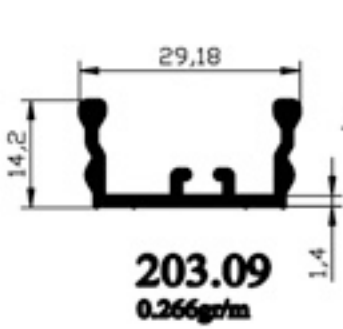

## MENFEZ ve RAY PROFİLLERİ 203

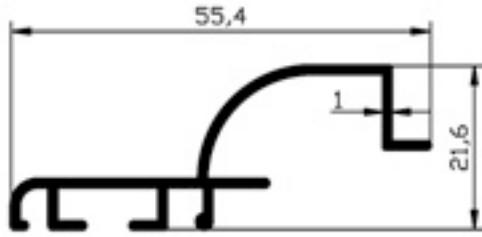

**203.18**  
0.305gr/m

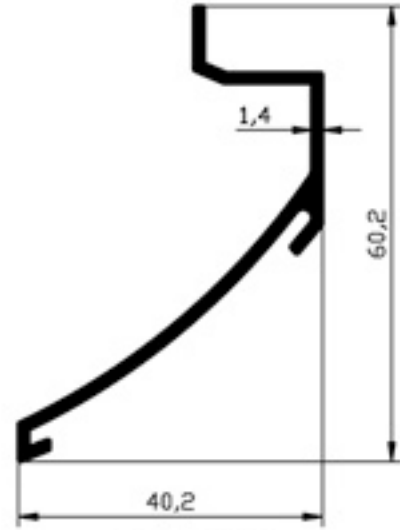

**203.19**  
0.408gr/m

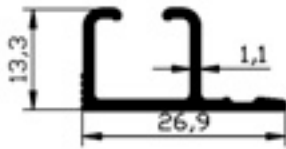

**203.20**  
0.175gr/m

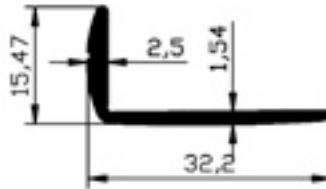

**203.22**  
0.189gr/m

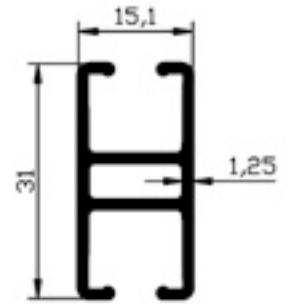

**203.21**  
0.314gr/m

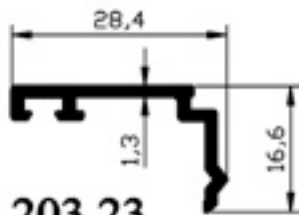

**203.23**  
0.186gr/m

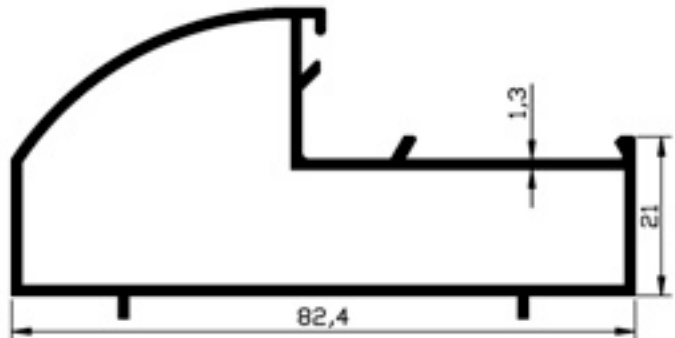

**203.24**  
0.865 gr/m

## KÜPEŞTE PROFİLLERİ 204

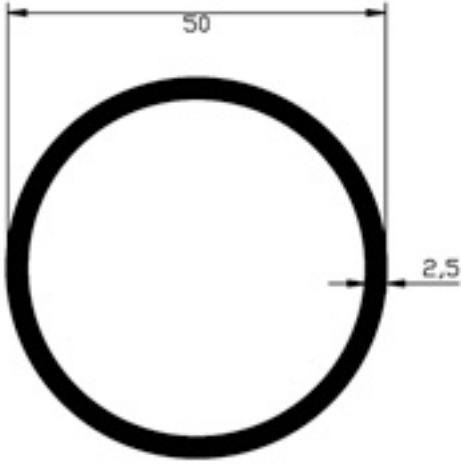

**605.23**  
1,010gr/m

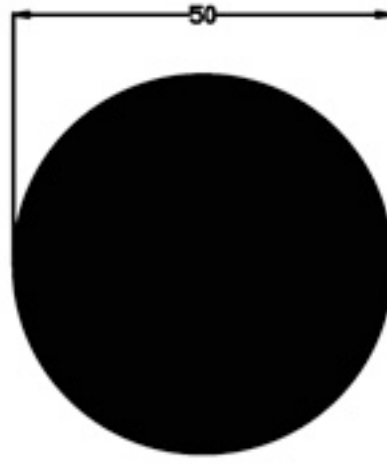

**607.01**  
5,321gr/m

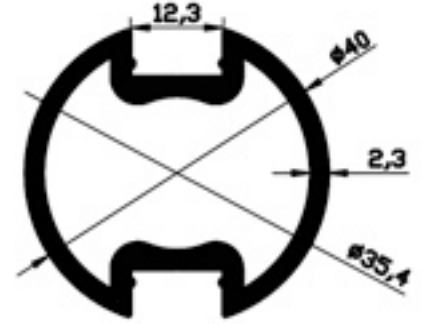

**204.01**  
0,942gr/m

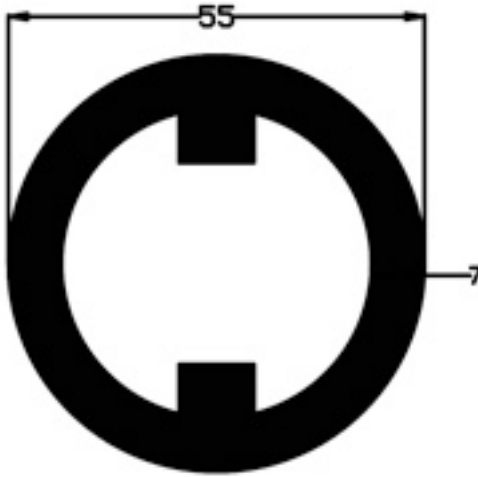

**204.02**  
3,423gr/m

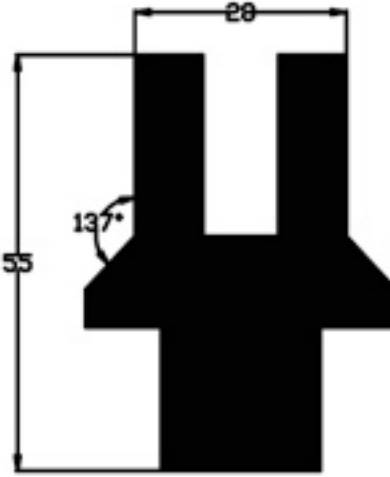

**204.03**  
2,482gr/m

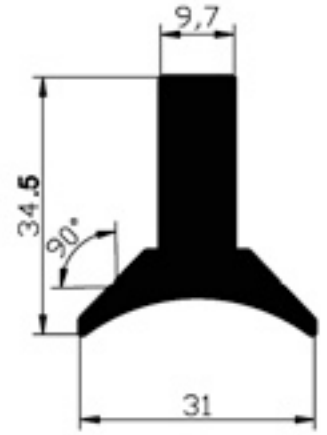

**204.04**  
1,888gr/m

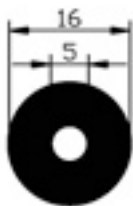

**605.25**  
0,491gr/m

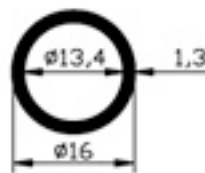

**605.11**  
0,162gr/m

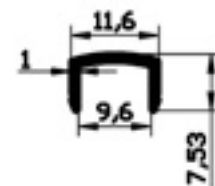

**204.06**  
0,059 gm/mt

## KÜPEŞTE PROFİLLERİ 204

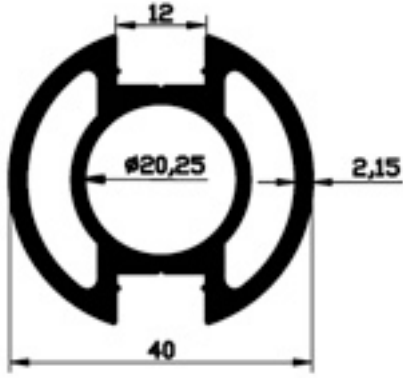

**204.07**  
1,098 gm/mt

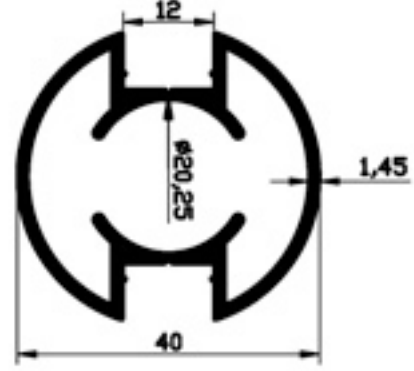

**204.10**  
0,728 gm/mt

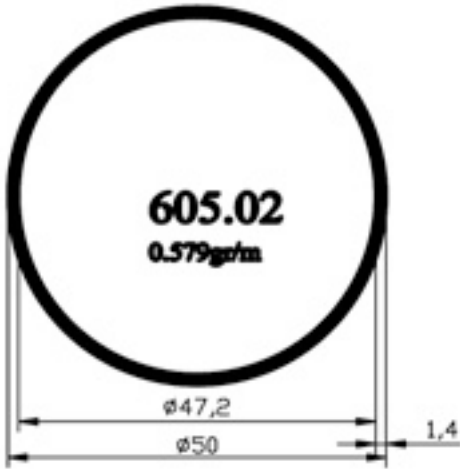

**605.02**  
0.579gr/m

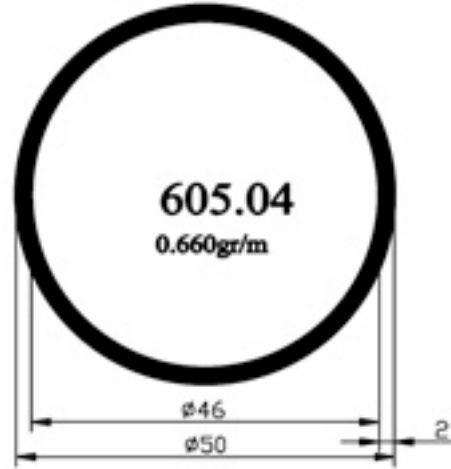

**605.04**  
0.660gr/m

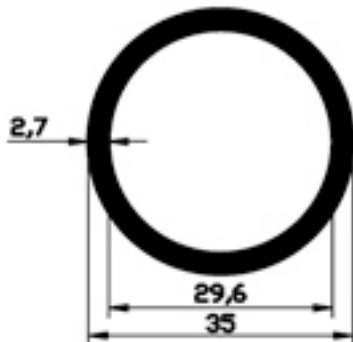

**605.31**  
0,900 gm/mt

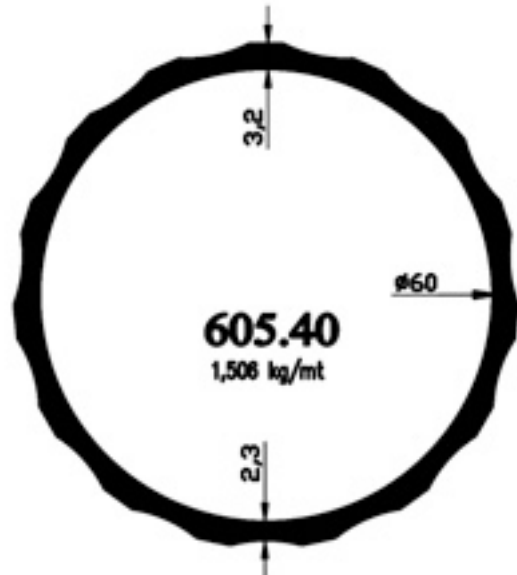

**605.40**  
1,508 kg/mt

## ISITICILAR 205

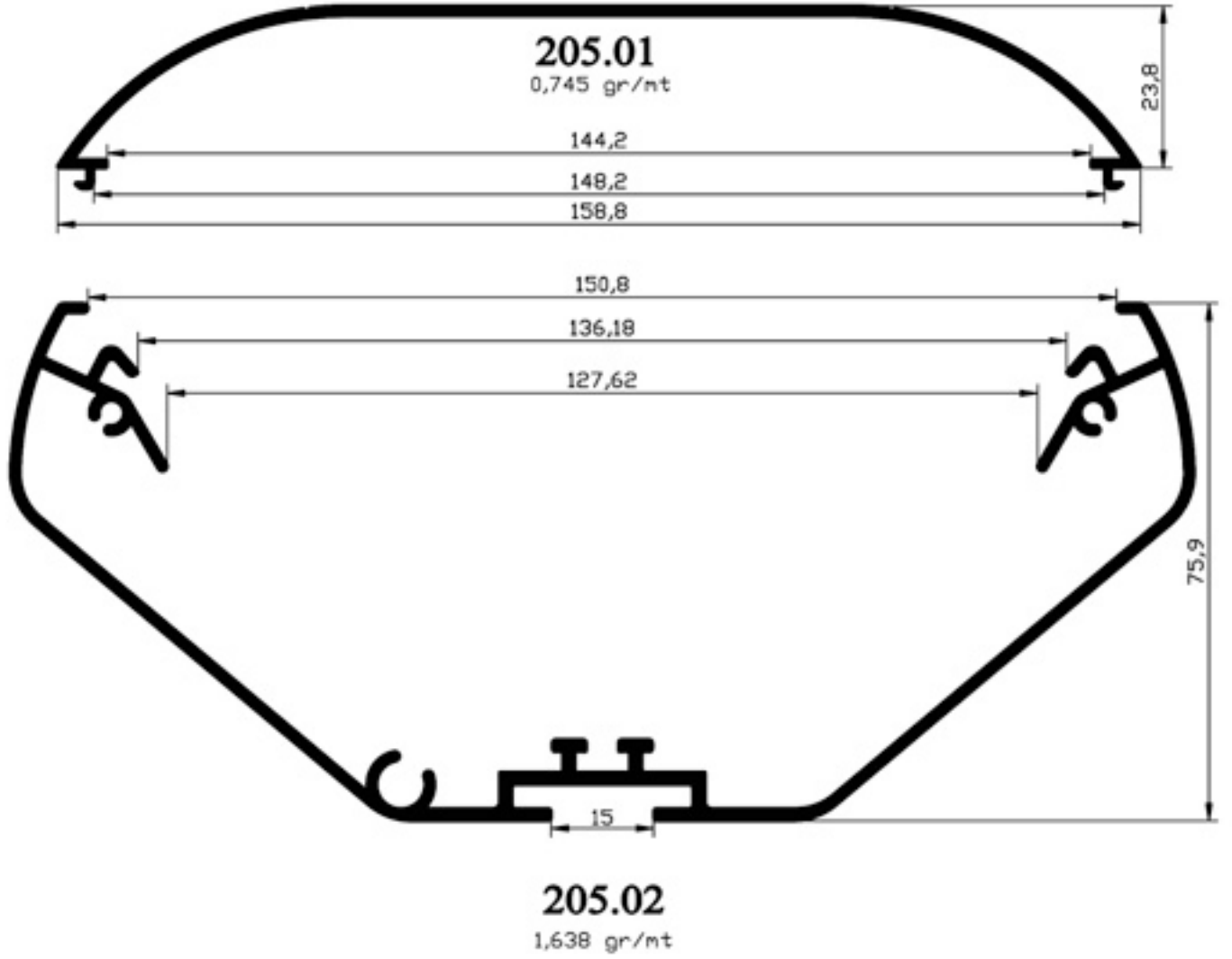

## ISITICILAR 205

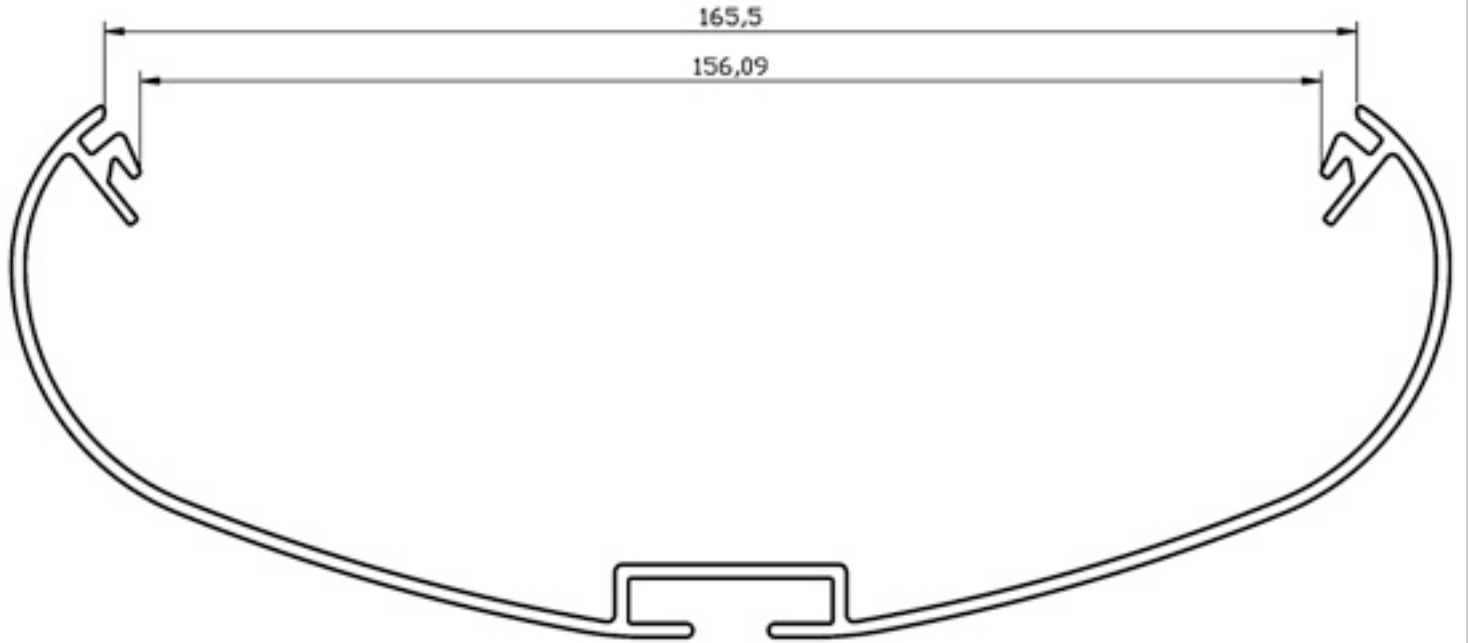
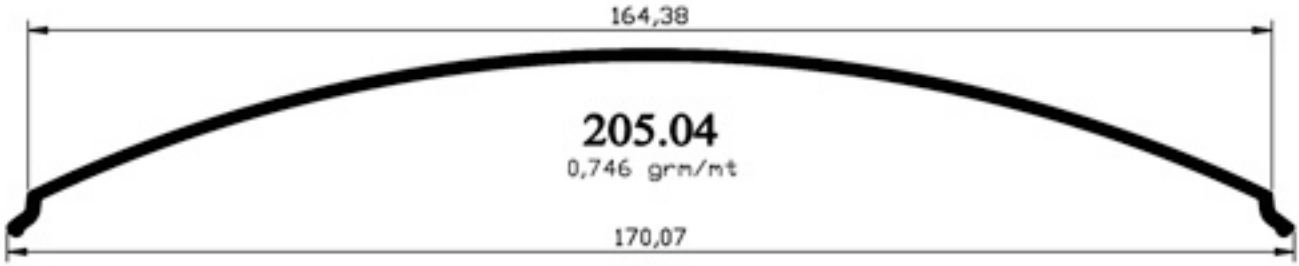

**205.03**

1,731 grn/mt

## RADYATÖR PETEKLERİ 206

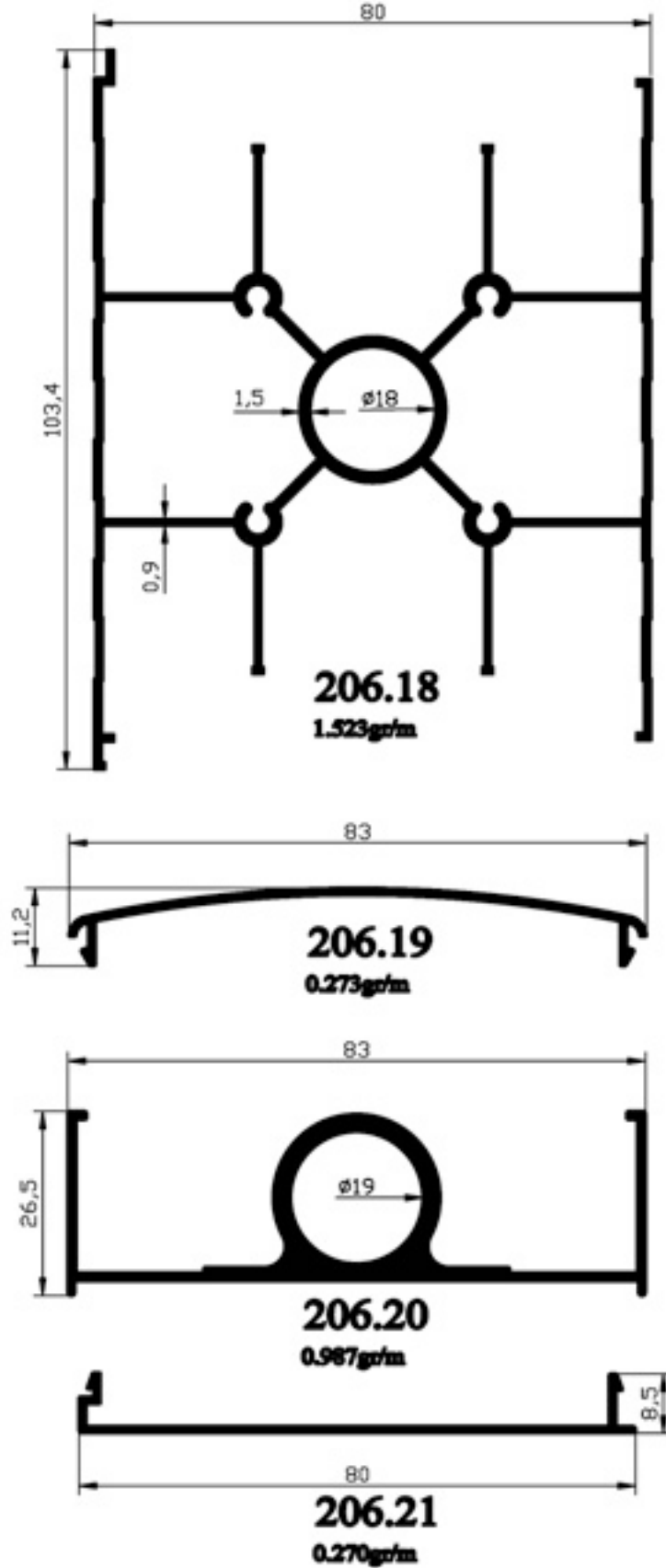

## SÜSLEME ve LAMBRİLER 207

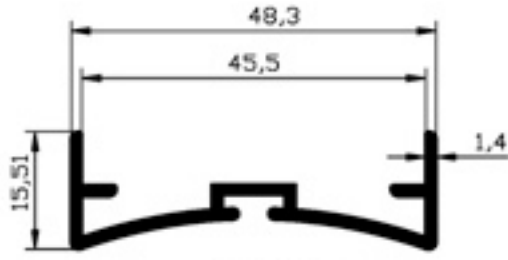

**207.01**  
ÇARPMA KAPI ADAPTÖRÜ  
0,360 gr/m



**207.03**  
50'LİK GRİYAJ  
0,430 gr/m

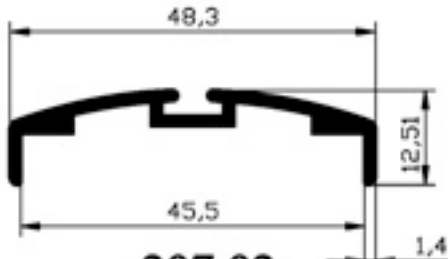

**207.02**  
ÇARPMA KAPI ADAPTÖRÜ  
0,330 gr/m

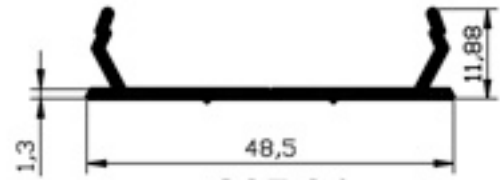

**207.04**  
50'LİK GRİYAJ ALTI  
0,250 gr/m

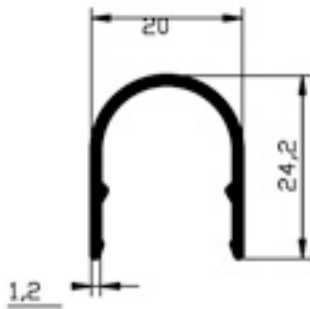

**207.05**  
20'LİK GRİYAJ  
0,200 gr/m



**207.06**  
20'LİK GRİYAJ ALTI  
0,100 gr/m



## SÜSLEME ve LAMBRİLER 207

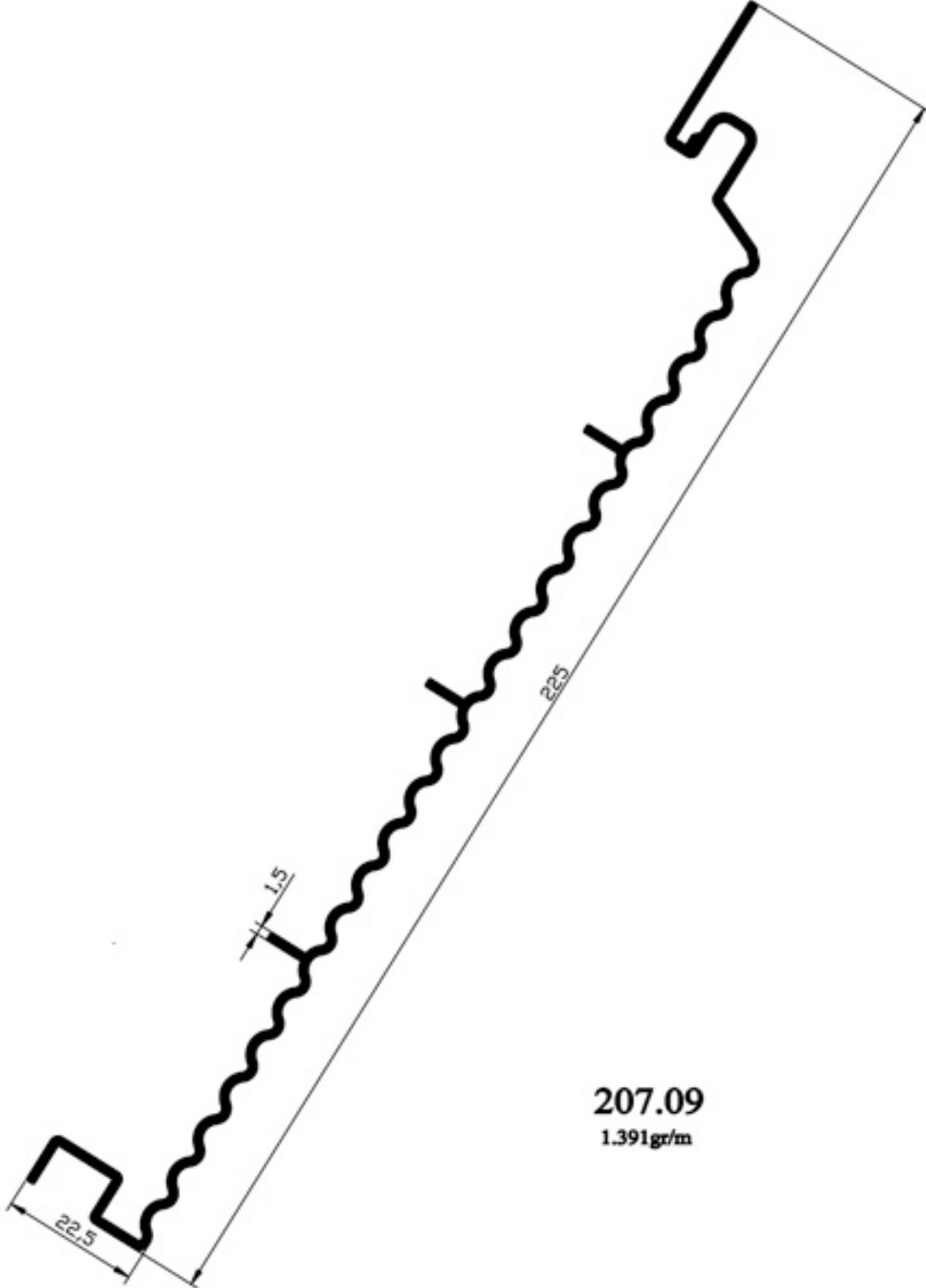

## SÜSLEME ve LAMBRİLER 207

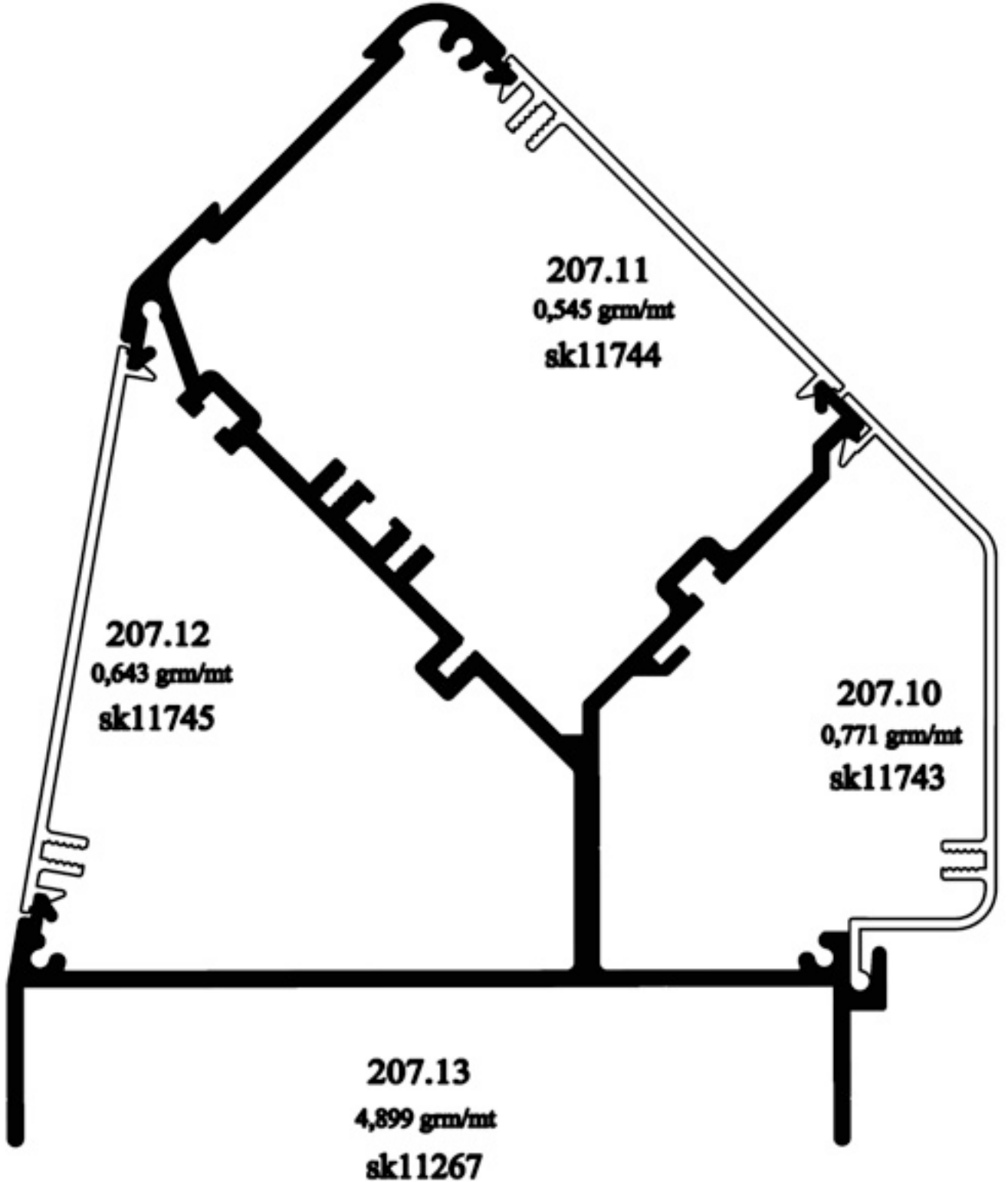

## SÜSLEME ve LAMBRİLER 207

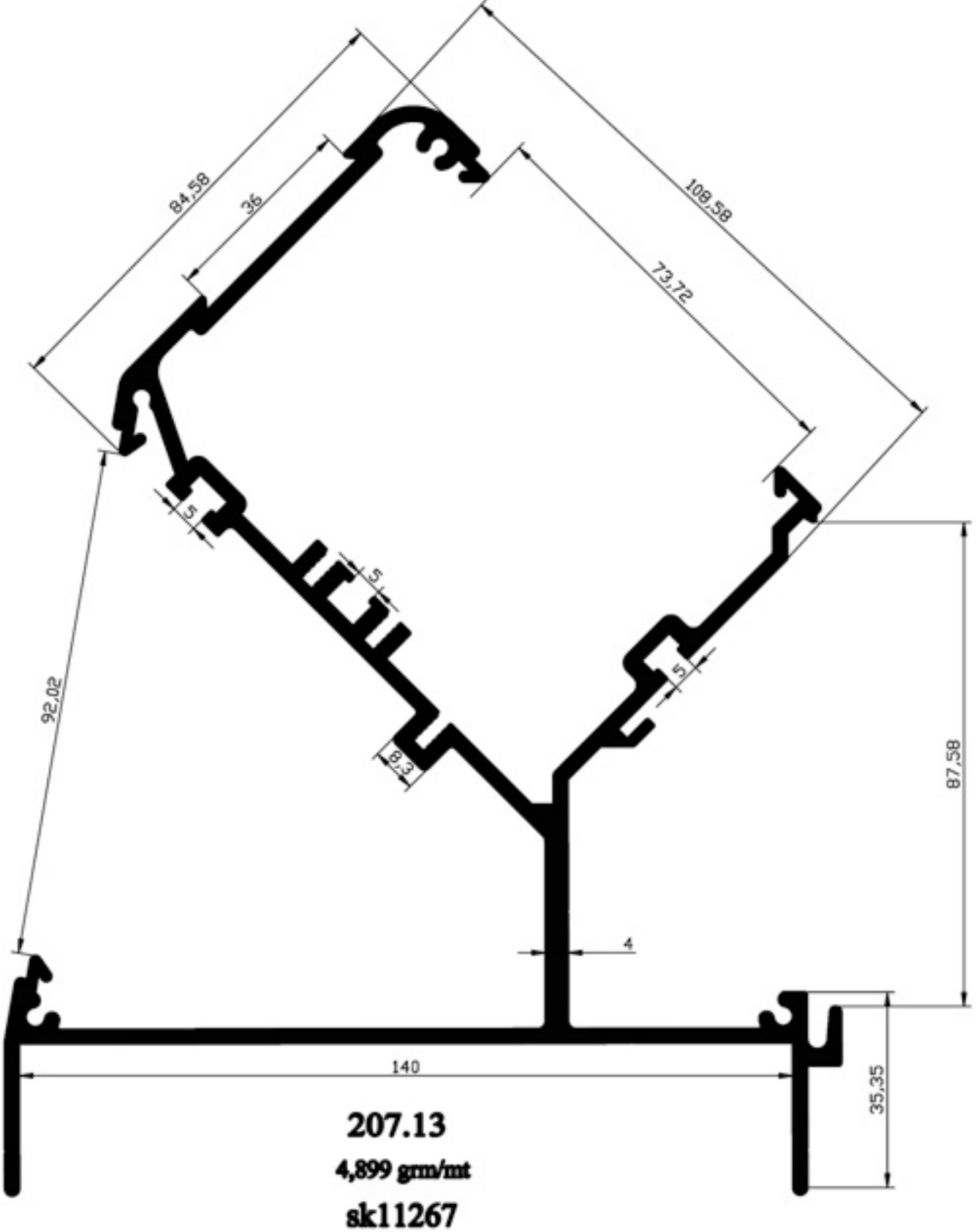

## SÜSLEME ve LAMBRİLER 207

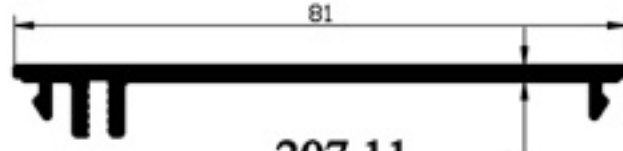

**207.11**  
**0,545 grm/mt**  
**sk11744**

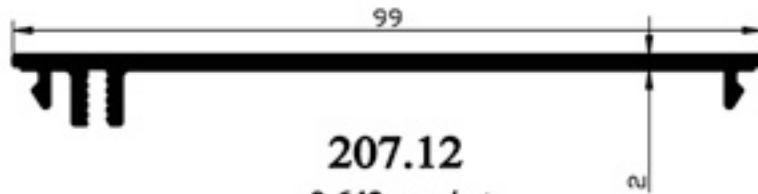

**207.12**  
**0,643 grm/mt**  
**sk11745**

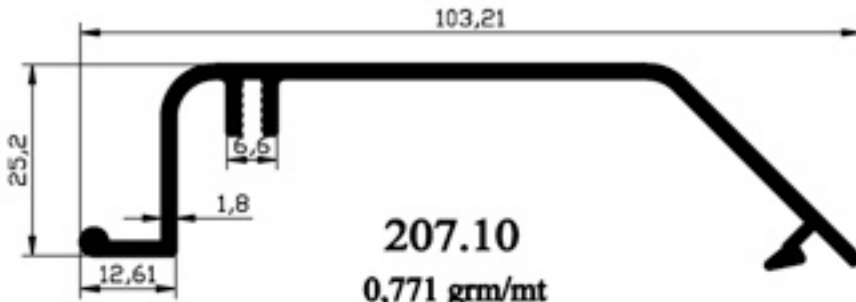

**207.10**  
**0,771 grm/mt**  
**sk11743**

## SÜSLEME ve LAMBRİLER 207

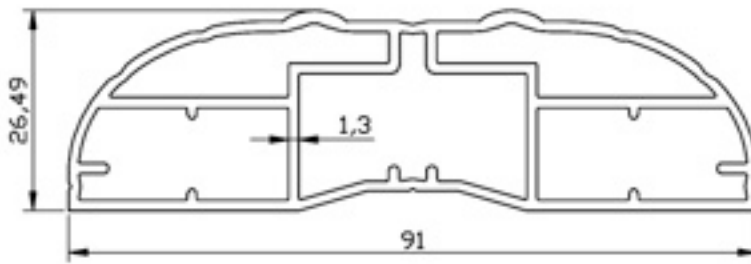
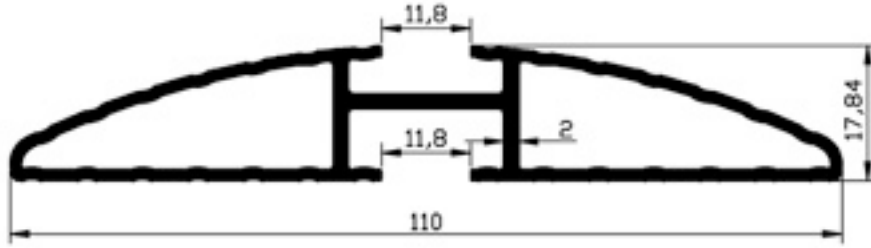

## SÜSLEME ve LAMBRİLER 207

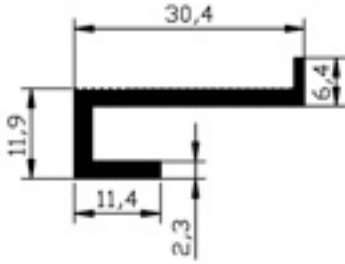

**207.16**  
0,308 grm/mt

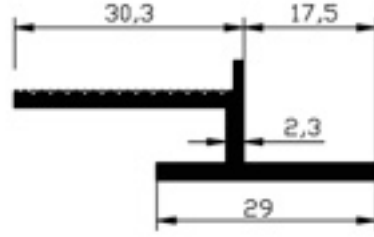

**207.17**  
0,416 grm/mt

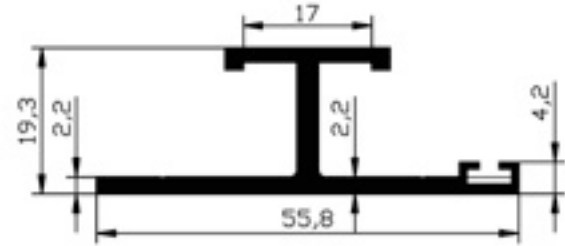

**207.18**  
0,575 grm/mt



**207.25**  
0,114 grm/mt



**207.30**  
0,138 grm/mt

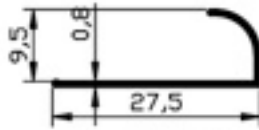

**207.31**  
0,089 grm/mt

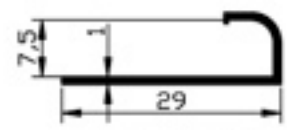

**207.32**  
0,116 grm/mt

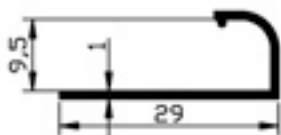

**207.33**  
0,125 grm/mt

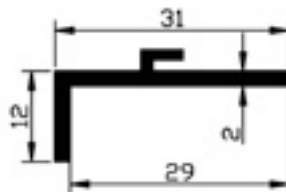

**207.37**  
0,247 grm/mt



**207.38**  
0,192 grm/mt

## SÜPER SERİ DUŞAKABİN 208

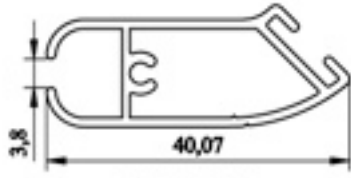

**208.01**  
0,367 gr/m

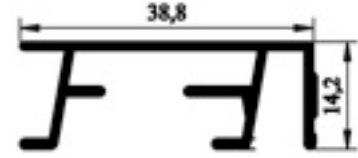

**208.02**  
0,324 gr/m

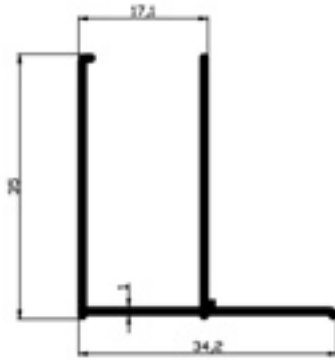

**208.03**  
0,281 gr/m

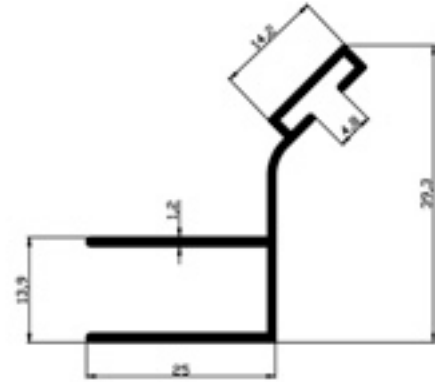

**208.04**  
0,302 gr/m



**208.05**  
0,222 gr/m

## SÜPER SERİ DUŞAKABİN 208

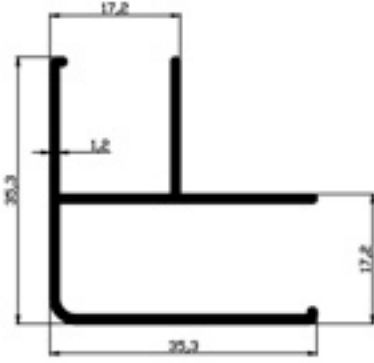

**208.06**  
0,392 gr/mt

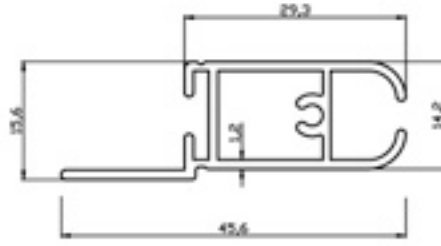

**208.07**  
0,383 gr/m

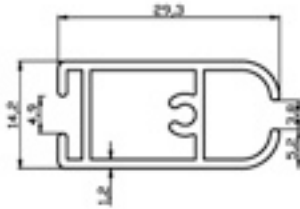

**208.08**  
0,321 gr/m

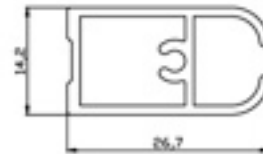

**208.09**  
0,294 gr/m



## 45'LİK SİSTEM SERİ PROFİLLERİ 301

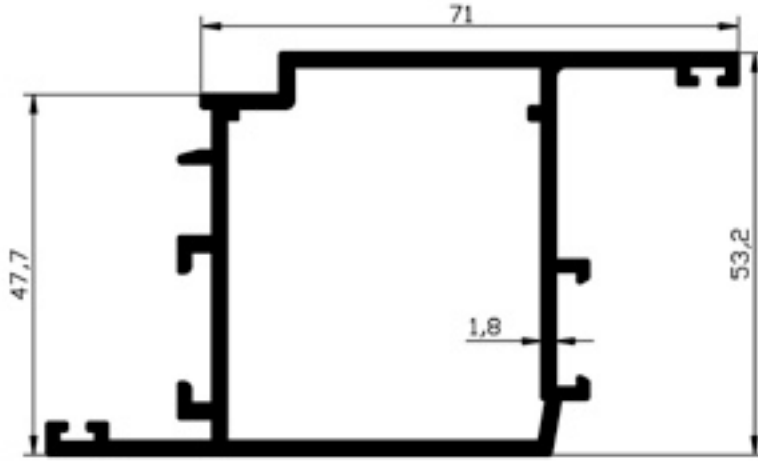

**301.01**  
**KANAT PROFİLİ**  
1.356gr/m

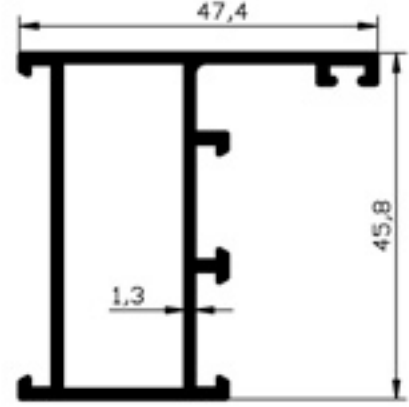

**301.02**  
**SİSTEM DAR KASA**  
0.671gr/m

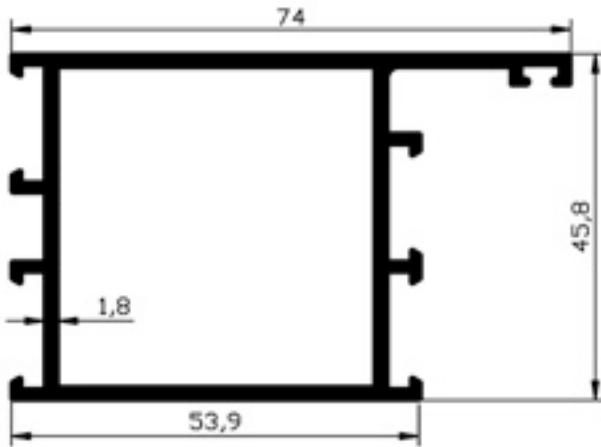

**301.03**  
**SİSTEM GENİŞ KASA**  
1.156gr/m

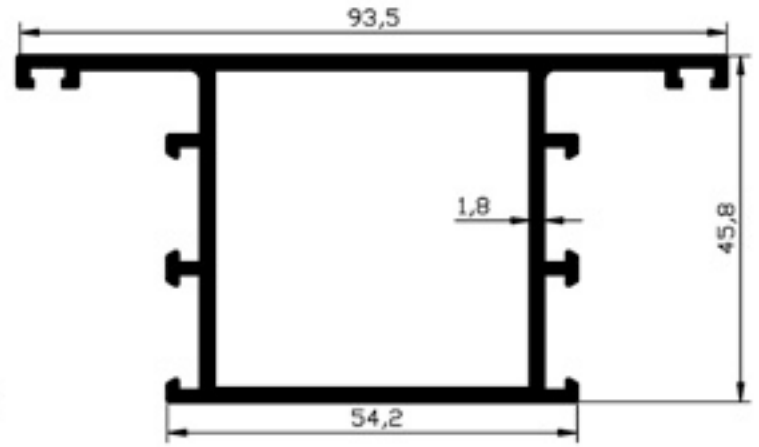

**301.04**  
**GENİŞ ÇİFT TIRNAK KASA**  
1.278gr/m

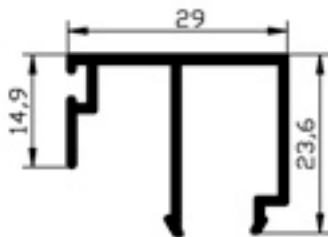

**301.05**  
**NORMAL CAM ÇİTASI**  
0.278gr/m

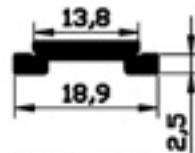

**326.50**  
**TİJ ÇUBUĞU**  
0.136 gr/m

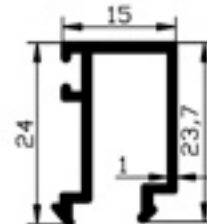

**301.07**  
**ISI CAM ÇİTASI**  
0.208gr/m

## 45'LİK SİSTEM SERİ PROFİLLERİ 301

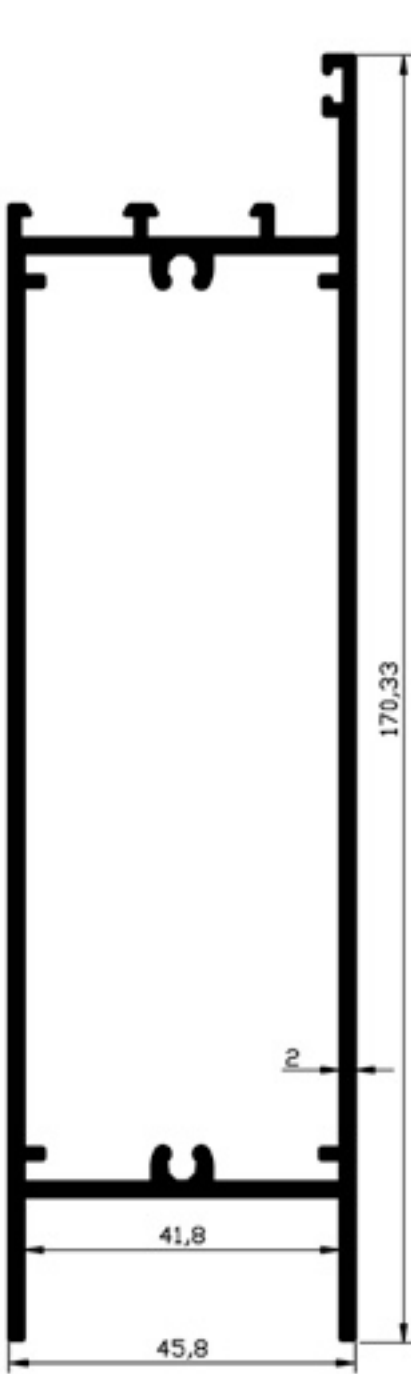

**301.08**  
**ALT BAZA**  
**2.402gr/m**

**301.09**  
**GENİŞ KANAT**  
**1.026gr/m**

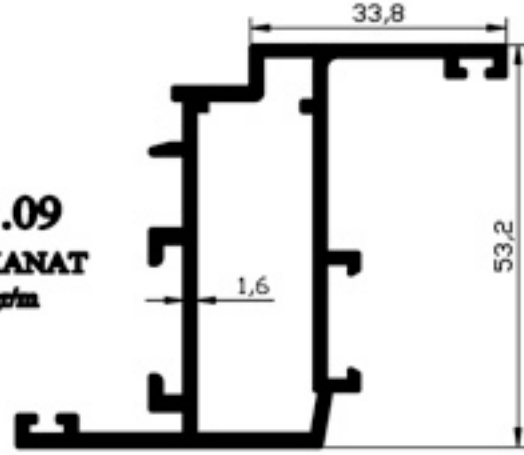

**301.10**  
**DAR KASA**  
**0.899gr/m**

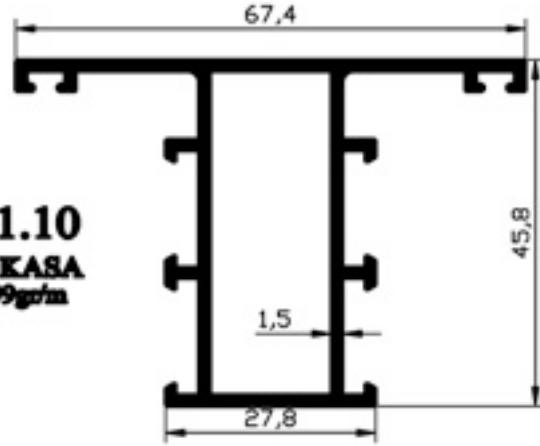

**301.11**  
**DAR KANAT**  
**0.853gr/m**

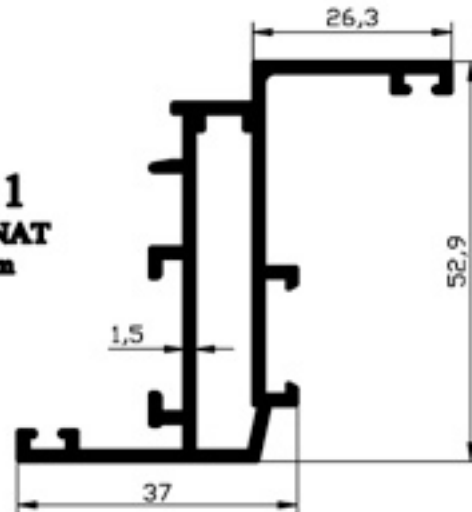

## 45'LİK SİSTEM SERİ PROFİLLERİ 301

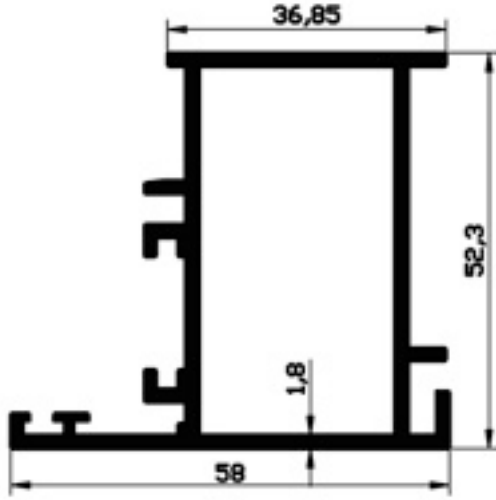

**301.12**  
PİVOT ADAPTÖR  
1,134 gr/mt

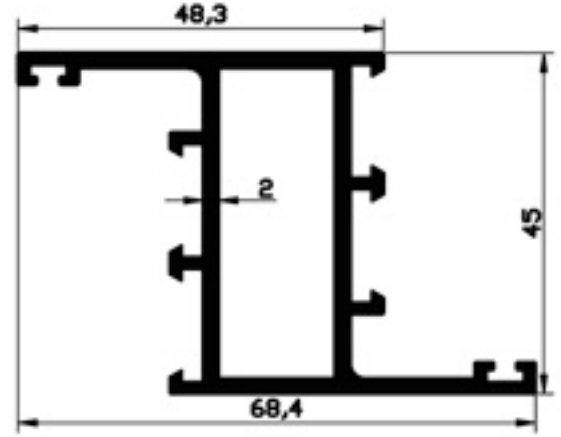

**301.13**  
1,093 gr/mt

## 55'LIK SİSTEM SERİ-1 302

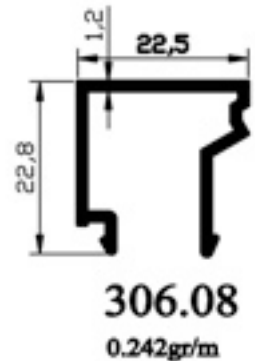
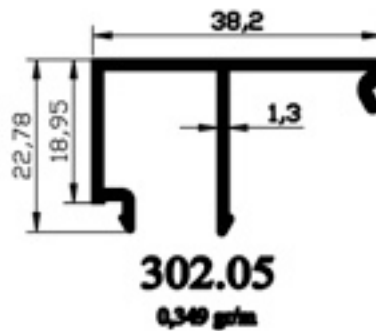
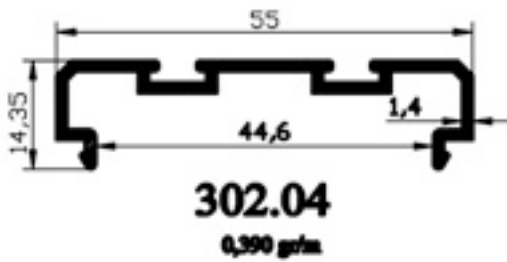
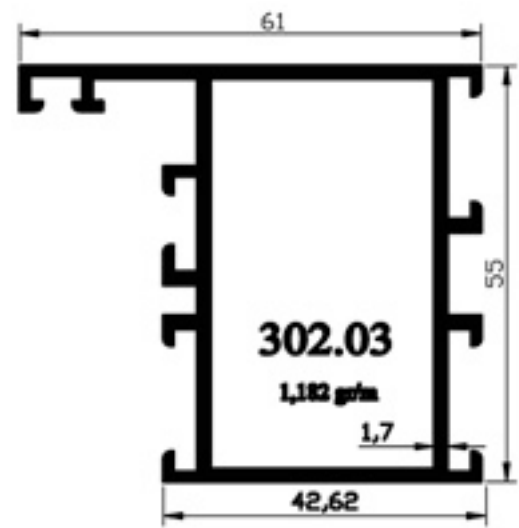
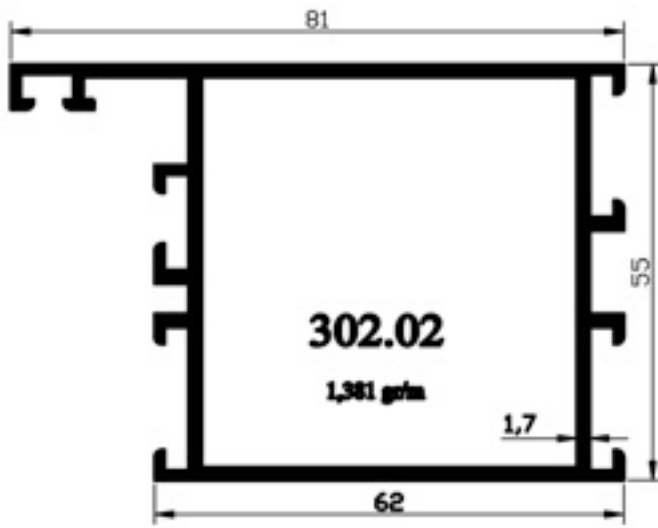
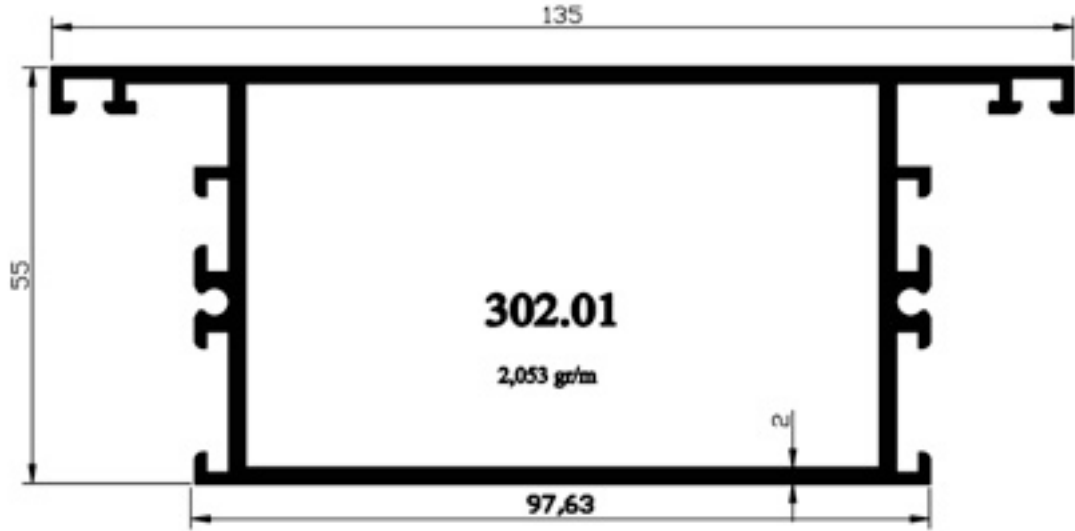

## 55'LİK SİSTEM SERİ-1 302

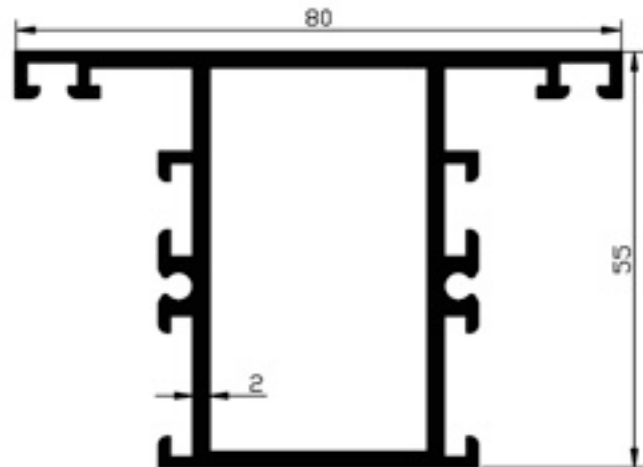
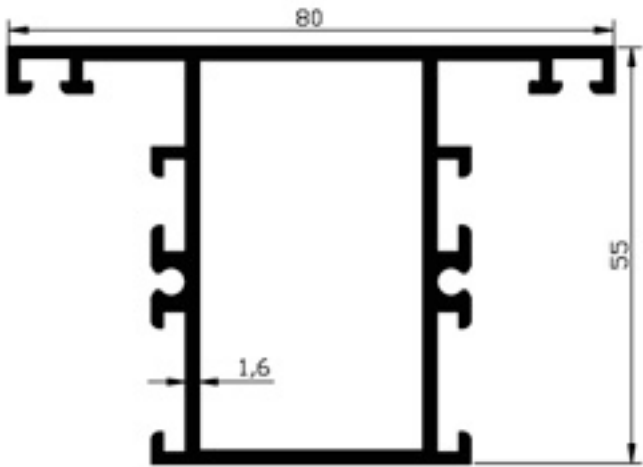
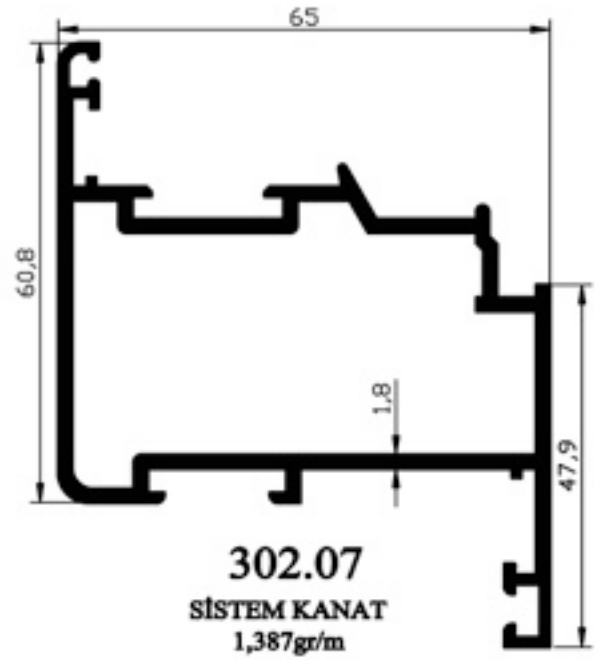
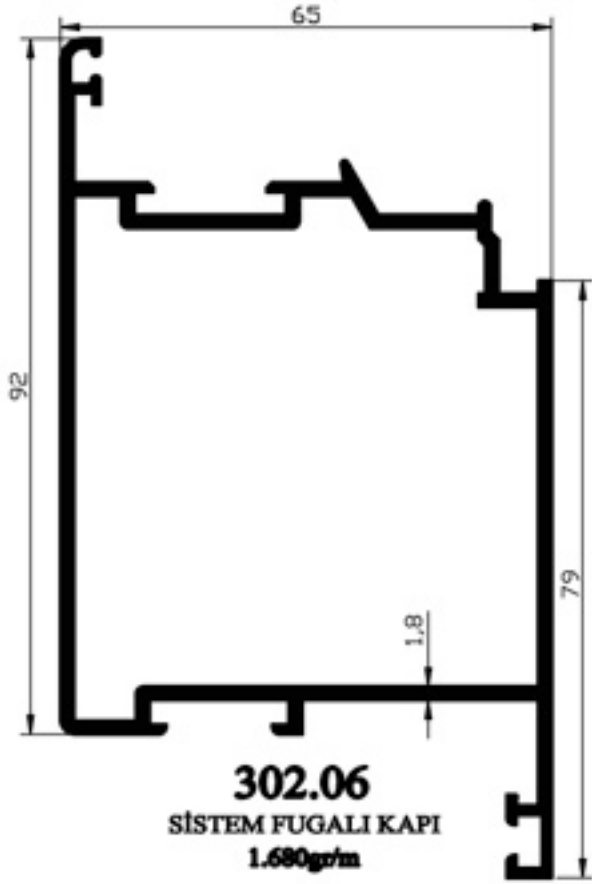

55'LİK SİSTEM SERİ-1 302

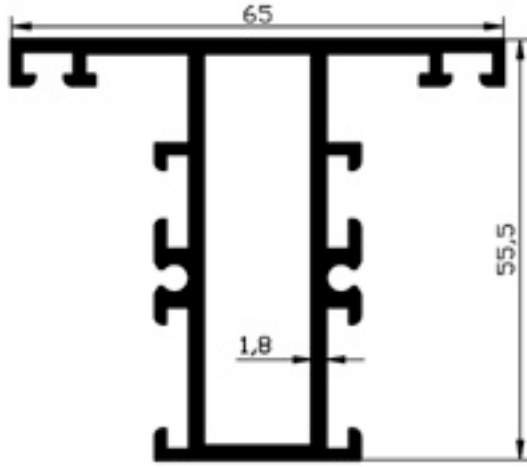

**302.10**  
DAR ORTA KAYIT  
1.228gr/m

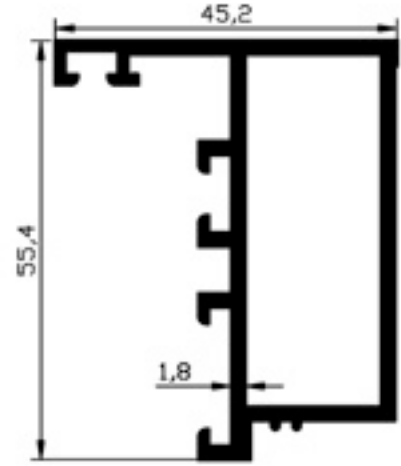

**302.11**  
DAR KASA  
0.969gr/m

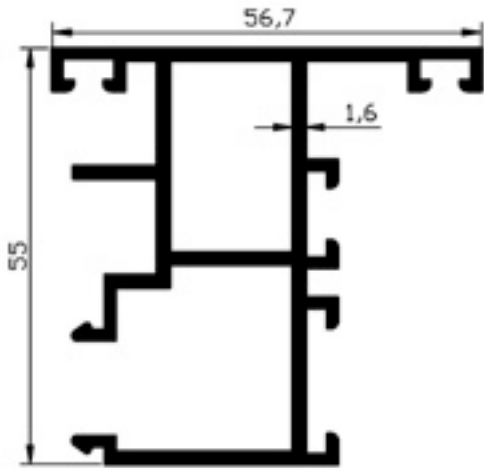

**302.12**  
ADAPTÖR  
1.087gr/m



**302.13**  
DİŐA AÇILIR KAPI  
2.049gr/m